



# R-Series v5 Instruction Manual

[geistglobal.com](http://geistglobal.com)



# Table of Contents

<b>Introduction</b>	<b>5</b>
Welcome.....	5
<b>About this Manual</b>	<b>7</b>
Revision History.....	8
Organization of the Manual.....	8
Audience Profile.....	8
On-line Documentation.....	8
Reporting Document Errors.....	9
Conventions.....	9
Software .....	9
Hardware .....	9
Safety .....	11
Figures .....	12
Tables .....	12
<b>Chapter 1 - Product Specifications</b>	<b>13</b>
<b>Product Specifications.....</b>	<b>13</b>
<b>Overview .....</b>	<b>13</b>
<b>Environmental .....</b>	<b>13</b>
Temperature.....	13
Humidity .....	14
Elevation .....	14
<b>Electrical .....</b>	<b>14</b>
Receptacle Ratings.....	14
<b>Networking .....</b>	<b>14</b>
Ethernet .....	15
Protocols .....	15
User Interfaces.....	15
<b>Regulatory Compliance .....</b>	<b>16</b>
Underwriters Laboratories (UL).....	16
CE .....	16
Federal Communications Commission (FCC).....	16
RoHS/WEEE.....	17
<b>Chapter 2 - Installation</b>	<b>18</b>
<b>Pre-Installation.....</b>	<b>18</b>
<b>Installation.....</b>	<b>19</b>
<b>Mounting .....</b>	<b>19</b>
Full Length Brackets.....	20
Mini "L" Brackets (SLB-4).....	21
Vertical Extension Brackets (VCB-1).....	21
Toolless Mounting Hardware (11621).....	22

Toolless Full Length Brackets (TLFL).....	22
Single Side Mount 2 Unit Brackets (TSMX2).....	23
Offset/Side Mount Brackets (EZB-1).....	23
7" Extension Brackets (XB-7).....	24
Flush Mount Brackets (FM).....	24
Adjustable Mount Brackets (AM).....	25
Panel Mount Brackets (PM).....	25
23" Conversion Mounting Brackets (23-RM).....	26
Cable Mount Brackets (CMB-1).....	26
19" Horizontal/Panel Mount Brackets (7938).....	27
<b>Network Setup</b> .....	<b>28</b>
<b>Chapter 3 - Setup</b> .....	<b>33</b>
<b>Hardware Interface</b> .....	<b>33</b>
<b>Web Interface</b> .....	<b>34</b>
<b>Sensors</b> .....	<b>35</b>
<b>Overview</b> .....	<b>35</b>
Configuration and Operation.....	37
<b>Alarms &amp; Warnings</b> .....	<b>42</b>
Alarms & Warnings Configuration.....	43
<b>Logging</b> .....	<b>46</b>
<b>System</b> .....	<b>48</b>
<b>Users</b> .....	<b>48</b>
<b>Network</b> .....	<b>53</b>
<b>Web Server</b> .....	<b>58</b>
<b>Reports</b> .....	<b>60</b>
<b>LDAP</b> .....	<b>61</b>
<b>Display</b> .....	<b>63</b>
<b>Time</b> .....	<b>64</b>
<b>SSH</b> .....	<b>64</b>
<b>Email</b> .....	<b>64</b>
<b>SNMP</b> .....	<b>66</b>
<b>Syslog</b> .....	<b>68</b>
<b>Admin</b> .....	<b>69</b>
<b>Locale</b> .....	<b>70</b>
<b>Utilities</b> .....	<b>70</b>
<b>Help</b> .....	<b>73</b>
<b>Info</b> .....	<b>73</b>
<b>Support Site</b> .....	<b>73</b>
<b>Communication</b> .....	<b>74</b>
<b>Serial Interface</b> .....	<b>74</b>
Setup .....	74
Communication.....	74
<b>Technical Support</b> .....	<b>76</b>
<b>Resetting PDU</b> .....	<b>76</b>
<b>Service and Maintenance</b> .....	<b>76</b>
<b>Using Microsoft Exchange as an SMTP server</b> .....	<b>77</b>
<b>Chapter 4 - Final Checkout</b> .....	<b>79</b>
<b>Product-Specific Safety Notices</b> .....	<b>79</b>
<b>General Safety</b> .....	<b>79</b>

Live Circuits Safety .....	79
Equipment Grounding .....	80
Electrostatic Discharge .....	80
Explosive Environment .....	80
Servicing and Adjustments .....	80
Repairs and Modifications .....	80

# Introduction

## Welcome

### Notice to Users

Geist, a division of Vertiv, Inc., reserves the right to make changes to this document without notice to any user or reseller of this product. Geist, a division of Vertiv, Inc., also reserves the right to substitute or terminate distribution of this document, with no obligation to notify any person or party of such substitutions or terminations.

### Copyrights

© 2018 - Geist, a division of Vertiv, Inc. All Rights Reserved.

### Trademarks

All Trademarks contained herein are registered to Geist, a division of Vertiv, Inc.

### Use and Disclosure Restrictions

The software and documentation contained in this publication are copyrighted materials.

### Recovery Act Buy American

Geist products adhere to the Buy American provisions of the American Recovery and Reinvestment Act of 2009 (Recovery Act). All Geist goods manufactured in our Lincoln, Nebraska, plant have undergone substantial transformation during production.

### Trade Agreements Act (TAA)

Geist goods manufactured in our Lincoln, Nebraska, plant have undergone substantial transformation during production. These Geist products adhere to U.S. Trade Agreements Act and can be supplied for GSA Schedules and other government contracts.

## Geist Policy on Conflict Minerals

This document details Geist's corporate policy regarding the use of conflict minerals. The policy expressed in this document should be considered to cover the Geist and Geist Europe divisions of Vertiv Inc.

Section 1502 of the Dodd-Frank Act which was passed by the US Congress in 2010 requires certain companies to annually disclose their use of conflict minerals. Conflict minerals covered under this act include tantalum, tin, tungsten, and gold.

Although Geist is not directly subjected to the requirements of the Dodd-Frank Act, Geist recognizes that all companies within the electronics manufacturing industry supply chain are impacted by this legislation. Geist supports the intent of the law, which is the reduction of violence within the Democratic Republic of the Congo and will take several actions to both advance the goals of the Dodd-Frank Act and to provide exceptional support to our customers.

- Geist will work with our direct suppliers to identify purchased components and materials that contain tin, tantalum, tungsten or gold.
- Geist will work with our direct suppliers to trace sources of any tin, tantalum, tungsten or gold used in our products back to the smelter.
- Geist will document our efforts to trace tin, tantalum, tungsten, and gold minerals back to the smelter and will accurately report the results to our customers.
- Geist will continue to monitor industry progress in identifying conflict-free smelters and will adjust corporate policy as the electronics supply chain becomes more fully documented.

Geist will not require that our direct suppliers source only conflict-free minerals until an adequate number of smelters has been reliably identified and audited by The Electronic Industry Citizenship Coalition (EICC) and the Global e-Sustainability Initiative (GeSI) to service the electronic industry supply chain. Mandating a conflict-free supply chain before an adequate number of smelters has been identified will prohibit the use of all tin, tantalum, tungsten, and gold originating in the Democratic Republic of the Congo and surrounding countries. This prohibition would cut off the sole income source for many artisanal miners within the region and may result in increased violence within the Democratic Republic of the Congo in direct opposition to the goals of the Dodd-Frank Act. Geist will work continuously with our direct suppliers in order to annually increase the percentage of documented conflict-free minerals that are used in our products until all products can be certified as conflict-free.

## WEEE Declaration

Geist Europe is obligated to finance the cost of the collection, treatment, recovery and environmentally sound disposal of all products sold by Geist Europe into the UK market this includes:

- New WEEE (displaying ‘the crossed out wheeled bin symbol’) that Geist Europe has placed onto the market after the 13th August 2005; and
- Historic WEEE (not displaying ‘the crossed out wheeled bin symbol’), when Geist Europe is supplying new WEEE that is intended to replace the historic WEEE and is of equivalent type or fulfills the same function even if the historic WEEE was manufactured by a third party.

Please contact Geist Europe on 01823 275100 for further details or to arrange collection. (UK Only)

## Document Usage

All reasonable efforts have been made to assure the accuracy of this document from any technical or typographical errors or omissions. Geist, a division of Vertiv, Inc., and its affiliates disclaim responsibility for any labor, materials, or costs incurred as a result of usage of this document. Nor shall Geist, a division of Vertiv, Inc., and its affiliates be liable for any damages, inclusive of loss of profits or data, arising from the use of or in connection with this document.

Geist, a division of Vertiv, Inc., reserves the right to make changes to this document without notice to any user or reseller of this product. Geist, a division of Vertiv, Inc., also reserves the right to substitute or terminate distribution of this document, with no obligation to notify any person or party of such substitutions or terminations.

## About this Manual

This document provides an overview of Geist product(s), the major topics covered include:

- Copyright, Trademarks, and Disclosure Restrictions.
- Instructions for installing, powering and using the equipment.
- Information that will aid in managing and maintaining the equipment.

## Revision History

Revision	Date	Notes	Approved By
1.0	3/16/2017	New manual for v5 firmware	SC
2.0	8/04/2017	Minor updates	SC
3.0	12/15/2017	Update for v5.2 release	SC
3.1	3/22/2018	Vertiv, UL, and CE updates	JB
3.2	5/9/2018	RoHS Statement Update	JB

## Organization of the Manual

This Geist document contains the following product information:

- **Product Specifications** - This chapter describes the major product characteristics and its functional role within the system. Where appropriate, reference to cabling among product components and to other Geist product(s) is provided.
- **Installation** - This chapter provides installation information for the preparation and use of Geist products as well as procedures required to adequately mechanically and electrically attach Geist product into supporting systems.
- **Setup** - This chapter provides instructions on power-up procedures after product installation and configuration of the software and features.
- **Final Checkout** - Technical Support guidelines and safety information are provided in this chapter.

## Audience Profile

This document is intended for use by authorized technicians experienced with same of similar product types and for personnel requiring guidance for equipment installation, operation, maintenance, and support.

## On-line Documentation

This document is available on-line and within the corresponding [Geist Product Manuals](#). Additional Geist product supporting [Videos](#), [Product Literature](#) and [Case Studies](#) can be found on the [Geist Resource](#) page.



Product firmware updates can be found and downloaded from the [Geist Support](#) site, under [Firmware Updates](#).

Should this product fail within its warranty period and be in need of repair or replacement, a Return Material Authorization may be obtained on-line from the [RMA Form](#) link located within the [Geist Support](#) site.

## Reporting Document Errors

Should you discover any error or identify a deficiency in this document, please take time to contact us at the following email address:

[Geist-Documents@geistglobal.com](mailto:Geist-Documents@geistglobal.com)

Please be sure to provide us with the document name, part number, and page number(s). Also, please provide us with description of the error or the deficiency for the document. If you would like for us to contact you, please provide us with your name and contact information.

Thank you for your time. We appreciate any comments and feedback you can provide.

## Conventions

The information contained within this document is established around the framework of various conventions, which are defined as follows:

### Software

- Release Management: Product name, Version control
  - Product Name: Name of Hardware Platform
  - Version control: V(ersion) Platform #, Major #, Minor #
    - Example: GU v3.0.0











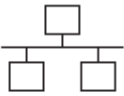

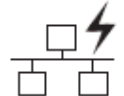



### Hardware

Product Classification

- Power Distribution Unit
  - Basic
  - Metered only
  - Monitored only
  - Switched only
  - Monitored + Switched
- Environmental Monitoring
  - Standard
  - Wireless

- Cooling
  - Passive
  - Active
- Data Center Infrastructure Management (DCIM)

Figure 1 Overlay Symbology Guide

	Ethernet		Activity / Idle
	Power over Ethernet		Power
	Serial		Amps
	Remote Display		Reboot
	Remote Sensors		Silence
	Uplink		Scroll
	Temp		GU Right
	Sensor Configuration		GU Left
		GU Center	

## Safety

This document contains varying levels of alerts pertaining to product and user safety. The alerts are visually presented with graphics and text per Geist equipment guidelines.

The representations are:

	<h3>DANGER</h3> <p>INDICATES AN <b>IMMINENT</b> HAZARDOUS SITUATION WHICH, IF NOT AVOIDED, WILL RESULT IN <b>DEATH OR SERIOUS INJURY</b>.</p>
---	---

	<h3>WARNING</h3> <p>INDICATES A <b>POTENTIAL</b> HAZARDOUS SITUATION WHICH, IF NOT AVOIDED, COULD RESULT IN <b>DEATH OR SERIOUS INJURY</b>.</p>
---	---

	<h3>CAUTION</h3> <p>INDICATES A <b>POTENTIAL</b> HAZARDOUS SITUATION WHICH, IF NOT AVOIDED, COULD RESULT IN <b>PRODUCT DAMAGE AND MINOR TO MODERATE INJURY</b>.</p>
---	---

	<h3>NOTE</h3> <p>Provides useful information that is beneficial for operation and usage of this product.</p>
---	--

## Figures

Figures presented in this document are identified and designated as follows:

'Figure:', Chapter # - Image #

Example:

---

Figure 1-1 Name and/or Title goes here

---

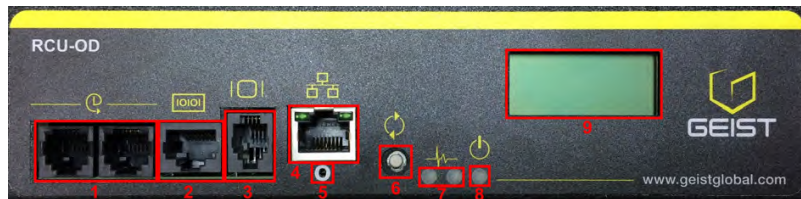

## Tables

Tables presented in this document are identified and designated as follows:

'Table:', Chapter # - Image #

Example:

---

Table 1-1 Name and/or Title goes here

---

Column 1	Column 2	Column 3	Column 4	Column 5
Text	Text	Text	Text	Text
Text	Text	Text	Text	Text
Text	Text	Text	Text	Text
Text	Text	Text	Text	Text

# Chapter 1 - Product Specifications

## Product Specifications

### Overview

The R-Series are rack level power distribution units (PDUs) with monitoring via a built-in web server. Web pages, including logging, are generated by the unit to monitor power and environmental conditions within the cabinet, several data formats are available. R-Series PDUs support optional external sensors. These units can be built for installation in single-phase, three-phase Delta or Wye building wiring configurations. There are four families within the R-Series; RCX, RCO, RCM-O and RCU-O

Table 1-1 R-Series Families

	Input Power Monitoring	Outlet Level Power Monitoring	Outlet Level Switching
RCX	•		
RCO	•	•	
RCM-O	•		•
RCU-O	•	•	•

### Environmental

The operational environmental limits pertaining to Temperature, Humidity and Elevation are as defined below.

#### Temperature

Table 1-2 Temperature Limits

	Minimum	Maximum
Operating	10°C (50°F)	45°C (113°F)
Storage	-25°C (13°F)	65°C (149°F)

## Humidity

Table 1-3 Humidity Limits

	Minimum	Maximum
Operating	5%	95% (non-condensing)
Storage	5%	95% (non-condensing)

## Elevation

Table 1-4 Elevation Limits

	Minimum	Maximum
Operating	0 m (0 ft)	2,000 m (6,500 ft)
Storage	0 m (0 ft)	15,240 m (50,000 ft)

## Electrical

Electrical product characteristics and performance are defined below. Also, please see the product nameplate for additional rating limits.

## Receptacle Ratings

Table 1-5 Receptacle Ratings

Type	Ratings
NEMA 5-15R or L5-15R	125Vac, 12A
NEMA 5-20R or L5-20R	125Vac, 16A
NEMA 6-20R or L6-20R	250Vac, 16A
NEMA L5-30R	125Vac, 24A
NEMA L6-30R	250Vac, 24A
IEC-60320 C13	250Vac, 10A (UL & CSA 12A, 250Vac)
IEC-60320 C19	250Vac, 16A (UL & CSA 16A, 250Vac)

## Networking

The product communications requirements are identified below.

## Ethernet

The Ethernet link speed for this product is: 10/100 Mb; full duplex.

## Protocols

The communications protocols supported by this product include: ARP, IPv4, IPv6, ICMP, ICMPv6, NDP, TCP, UDP, DNS, HTTP, HTTPS (TLSv1.2), SMTP, SMTPS, DHCP, SNMP (v1/v2c/v3), LDAP, NTP, SSH, and Syslog.

## User Interfaces

This product supports the following user interfaces: SNMP, JSON-based Web GUI, and Command-line interface using SSH or Serial (RS-232).

## Regulatory Compliance

Geist products are regulated for Safety, Emissions, and Environment Impact per the below agencies and policies.

### Underwriters Laboratories (UL)

UL Standards are used to assess products; test components, materials, systems and performance; and evaluate environmentally sustainable products, renewable energies, food and water products, recycling systems and other innovative technologies.

The UL standards specific to this equipment are listed in the UL Online Certification Library under the file number noted on the device name plate.

### CE

The placement of the CE mark on a product signifies a manufacturer's declaration that the product complies with the applicable European (EU) health, safety, and environmental protection requirements, including EU legislation and product directives. The CE mark is required for products offered for sale within the European Economic Area (EEA).

The specific regulations, directives, and standards applicable to each product are specified on the Declaration of Conformity.

### Federal Communications Commission (FCC)

The Federal Communications Commission (FCC) regulates interstate and international communications by radio, television, wire, satellite, and cable in all 50 states, the District of Columbia and U.S. territories. An independent U.S. government agency overseen by Congress, the commission is the United States' primary authority for communications laws, regulation and technological innovation.

The FCC standards specific to this equipment are:

This Class A device complies with part 15 of the FCC Rules. Operation is subject to the following two conditions:

- (1) This device may not cause harmful interference
- (2) This device must accept any interference received, including interference that may cause undesired operation.

This Class A digital apparatus complies with Canadian ICES-003.

Cet appareil numérique de la classe A est conforme à la norme NMB-003 du Canada.



**WARNING**

Changes or modifications to this unit not expressly approved by the party responsible for compliance could void the user's authority to operate this equipment.

**RoHS/WEEE**

Directive 2011/65/EU outlines the restriction of the use of hazardous substances in electrical and electronic equipment (EEE) with a view to contributing to the protection of human health and the environment, including the environmentally sound recovery and disposal of waste EEE.

Restricted substances and their respective maximum concentration values are listed below.

<b>Restricted Substance</b>	<b>Maximum Concentration Value (w/w)</b>
Cadmium (Cd):	0.01%
Mercury (Hg):	0.10%
Lead (Pb):	0.10%
Hexavalent chromium (Cr6+):	0.10%
Polybrominated biphenyls (PBB):	0.10%
Polybrominated diphenyl ethers (PBDE):	0.10%
**Bis(2-Ethylhexyl) phthalate (DEHP):	0.10%
**Butyl Benzyl phthalate (BBP):	0.10%
**Dibutyl phthalate (DBP):	0.10%
**Diisobutyl phthalate (DIBP):	0.10%

**NOTE**

DEHP, BBP, DBP, and DIBP restrictions are in effect as of July 2019.

## Chapter 2 - Installation

### Pre-Installation

- For standard temperature models, the ambient temperature of the installation location, such as an IT rack, should be no greater than 45°C if the PDU is loaded to its full nameplate current rating. The ambient temperature of the installation location should be not greater than 60°C if the PDU normal current load is a maximum 50% of the nameplate and individual receptacle ratings.



#### NOTE

(Note: load up to full nameplate rating are permitted during short term abnormal operating conditions).

- Install the PDU such that the amount of airflow required for safe operation of equipment is not compromised.
- Mount the PDU so that a hazardous condition is not achieved due to uneven mechanical loading.
- Follow nameplate ratings when connecting equipment to the branch circuit. Take into consideration the effect that overloading of the circuits might have on overcurrent protection and supplied wiring.
- The PDU relies on the building installation for protection from overcurrent. A certified overcurrent protection device is required in the building installation. The overcurrent protection device should be sized according to the PDU's nameplate ratings and local/national electrical code.
- Reliable earthing of rack-mount equipment should be maintained. Particular attention should be given to supply connections other than direct connections to the branch circuit. The PDU must be connected to an earthed socket outlet.
- PDU is intended for restricted-access locations. Only qualified service personnel should install and access the PDU.
- For pluggable equipment, install the PDU so the input plug or appliance coupler may be disconnected for service.
- The PDU is intended for indoor use only. Do not install the unit in wet or outdoor environments, and do not install it next to water tanks or plumbing.
- The PDU is intended for use with TN, TT, or IT power supply systems.

## Installation

1. Using appropriate hardware, mount unit to rack. See next section for examples.
2. Plug PDU into an appropriately-rated and protected branch-circuit receptacle.
3. Plug in the devices to be powered by the PDU.
4. Turn on each device connected to the PDU. Sequential power-up is recommended to avoid high inrush current.

## Mounting

Optional brackets sold separately.

1. Using appropriate hardware, mount unit to rack. (See below examples.)
2. Plug PDU into an appropriately-rated and protected branch-circuit receptacle.
3. Plug in the devices to be powered by the PDU.
4. Turn on each device connected to the PDU. Sequential power-up is recommended to avoid high inrush currents.

### Full Length Brackets

Figure 2-1 Full Length Bracket

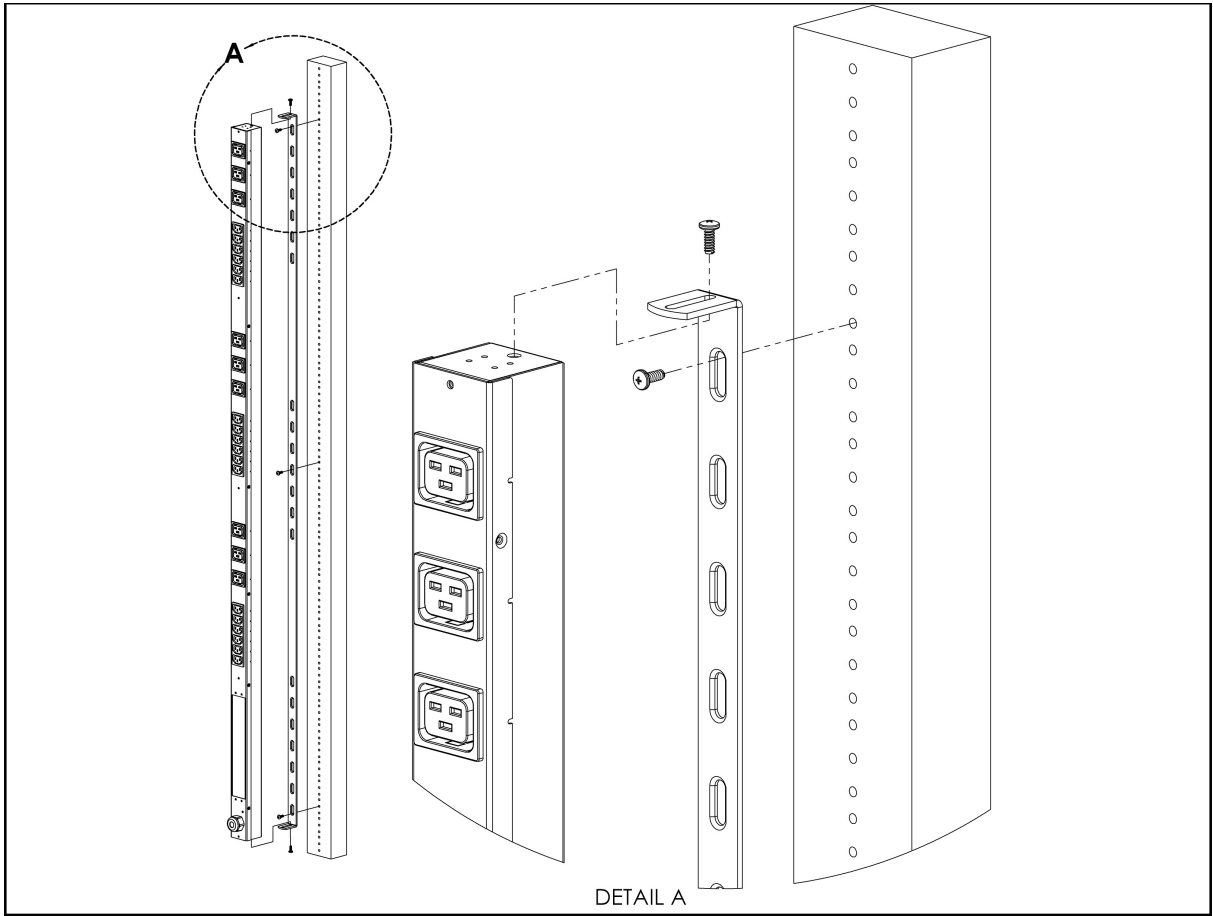

### Mini "L" Brackets (SLB-4)

Figure 2-2 Mini L Brackets

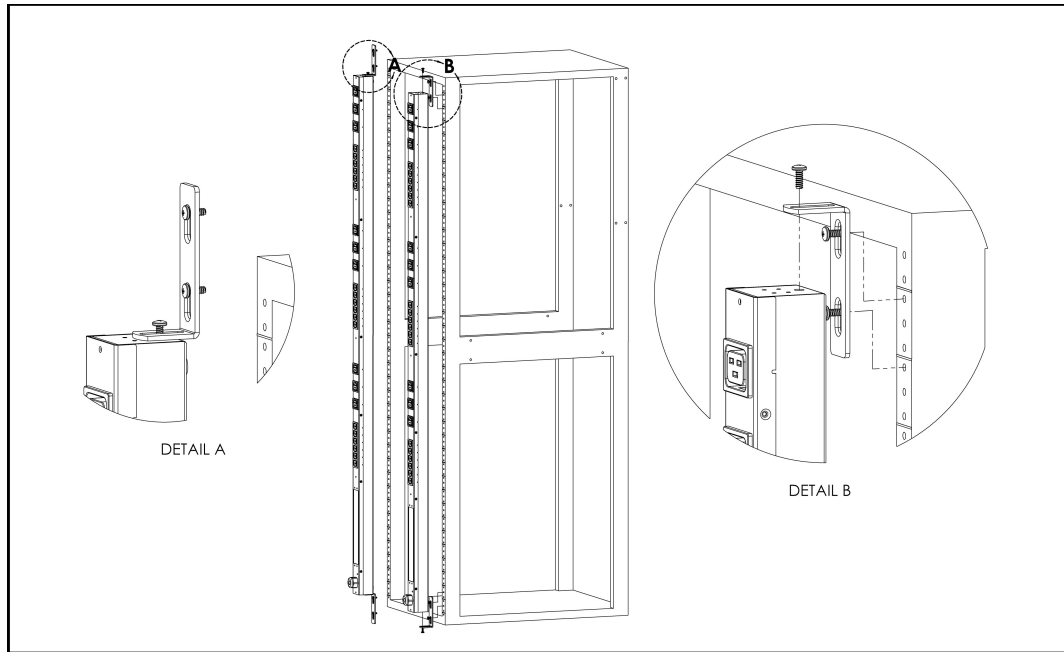

### Vertical Extension Brackets (VCB-1)

Figure 2-3 Vertical Extension Brackets

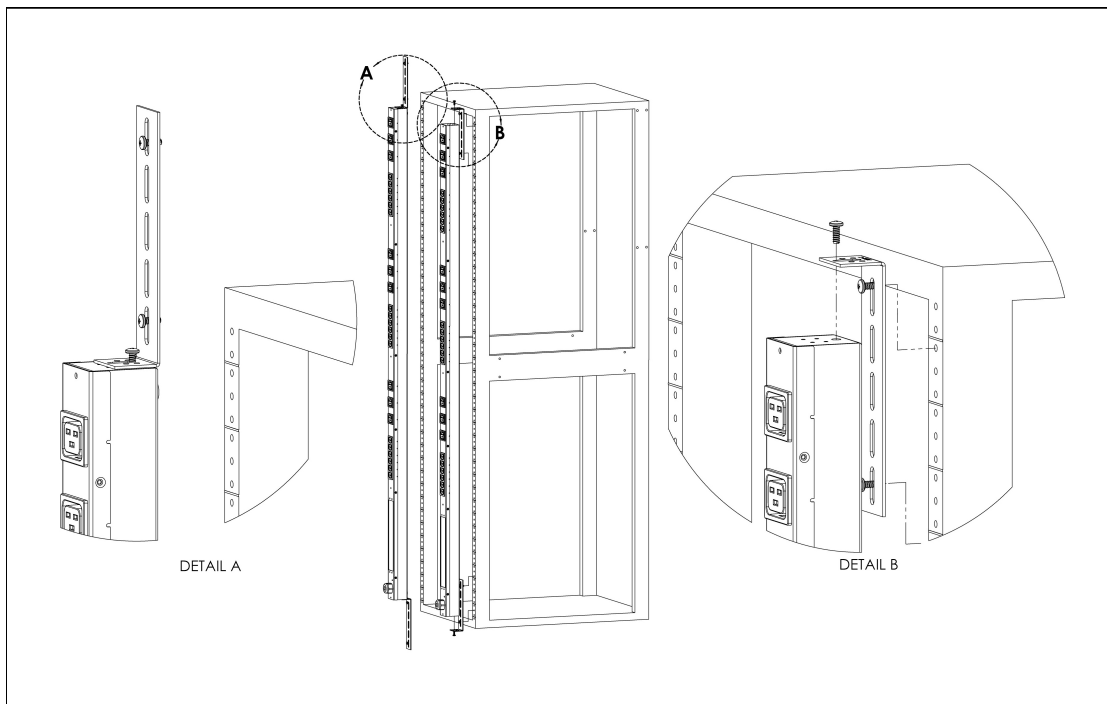

## Toolless Mounting Hardware (11621)

Figure 2-4 Toolless Mounting Hardware

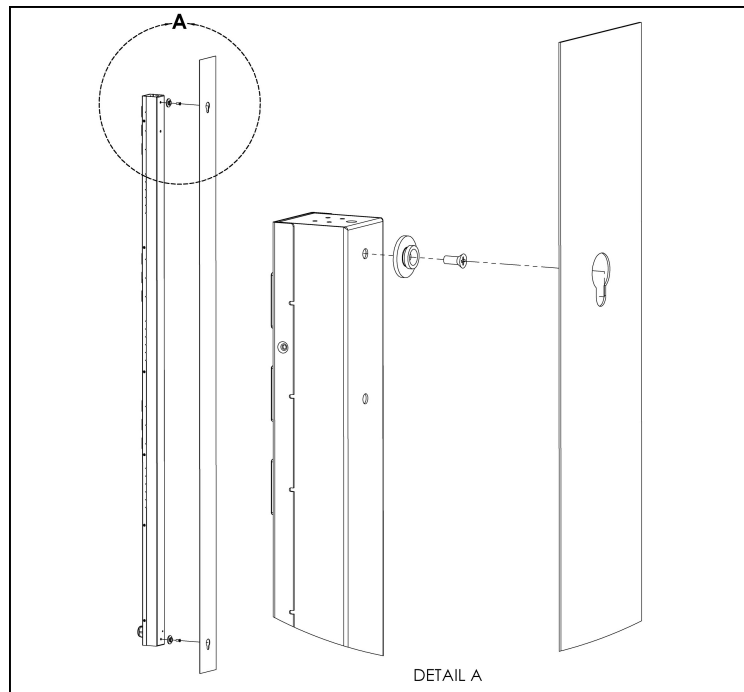

## Toolless Full Length Brackets (TLFL)

Figure 2-5 Toolless Full Length Brackets

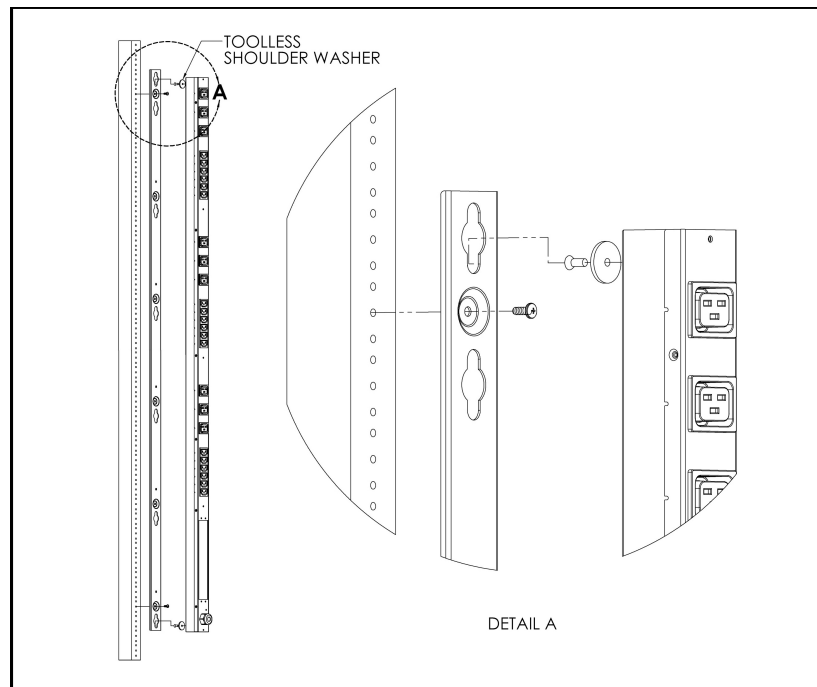

### Single Side Mount 2 Unit Brackets (TSMX2)

Figure 2-6 Single Side Mount 2 Units Brackets

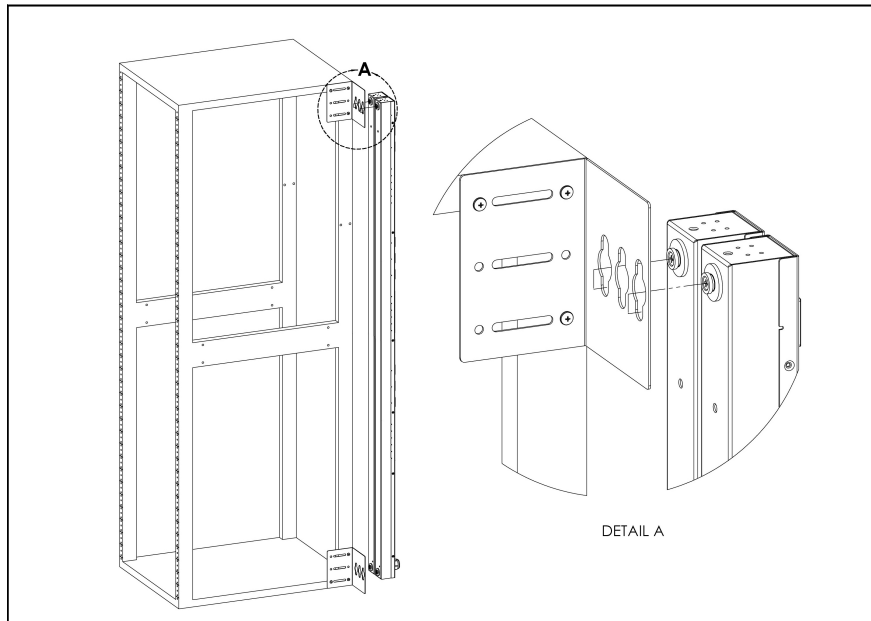

### Offset/Side Mount Brackets (EZB-1)

Figure 2-7 Offset/Side Mount Brackets

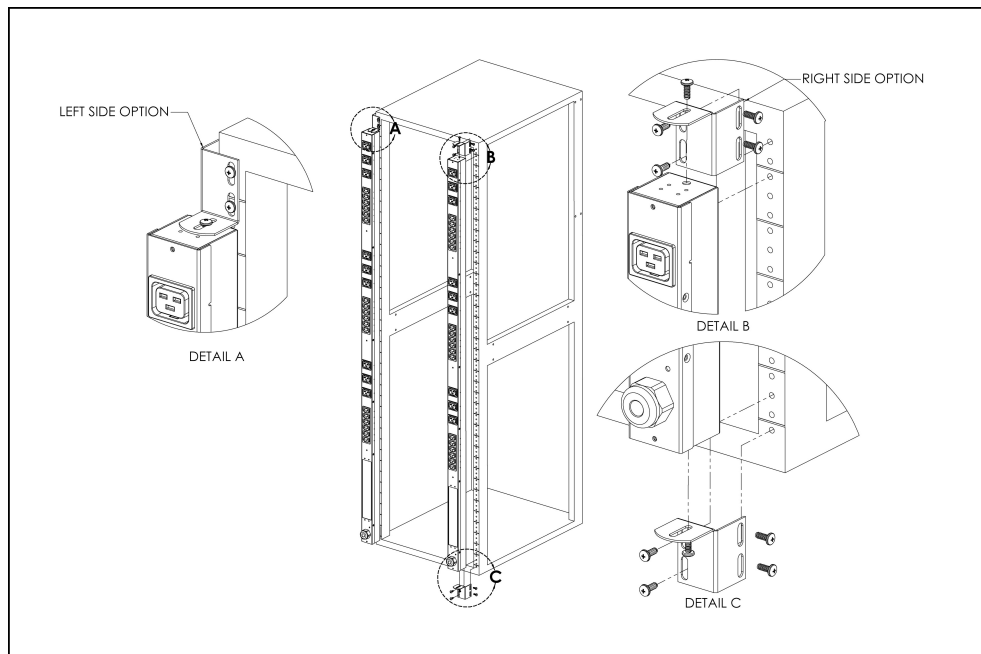

## 7" Extension Brackets (XB-7)

Figure 2-8 7" Extension Brackets

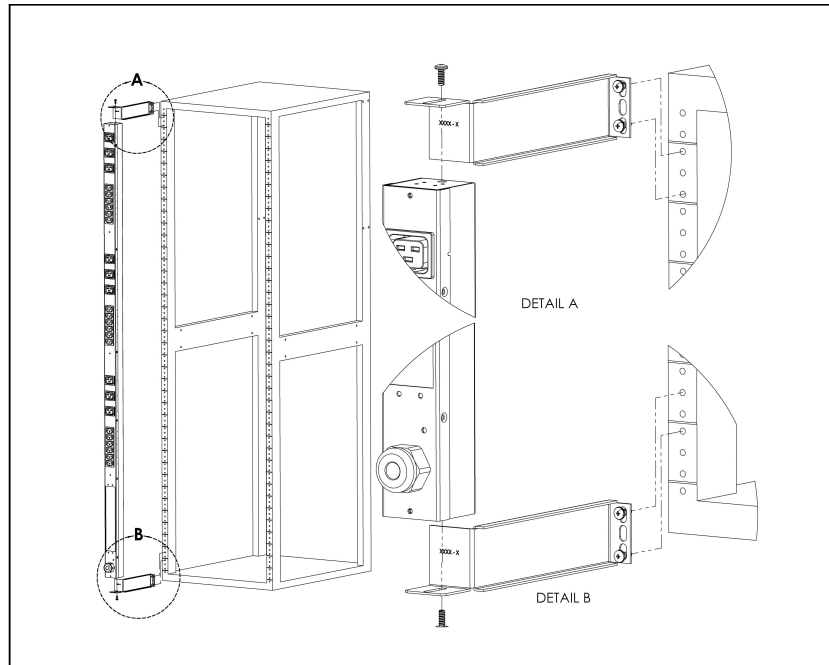

## Flush Mount Brackets (FM)

Figure 2-9 Flush Mount Brackets

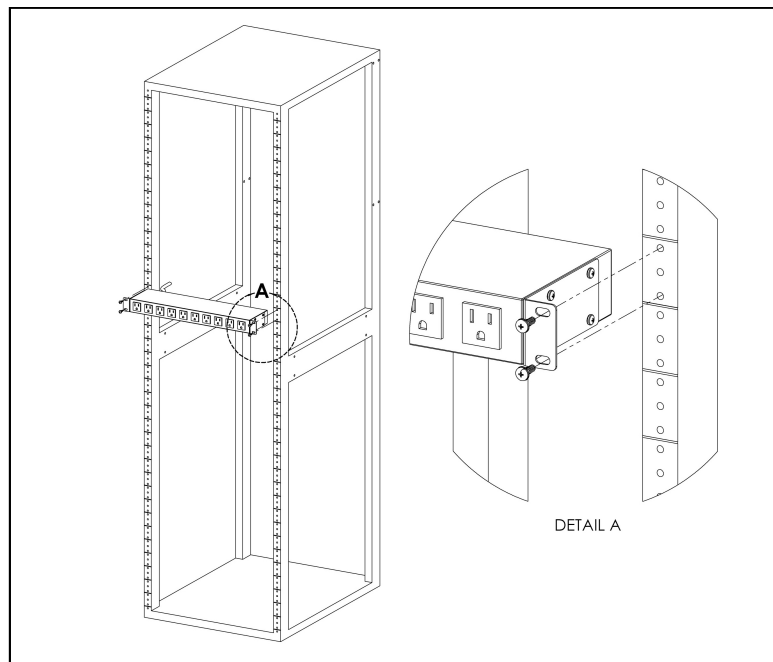



### Adjustable Mount Brackets (AM)

Figure 2-10 Adjustable Mount Brackets

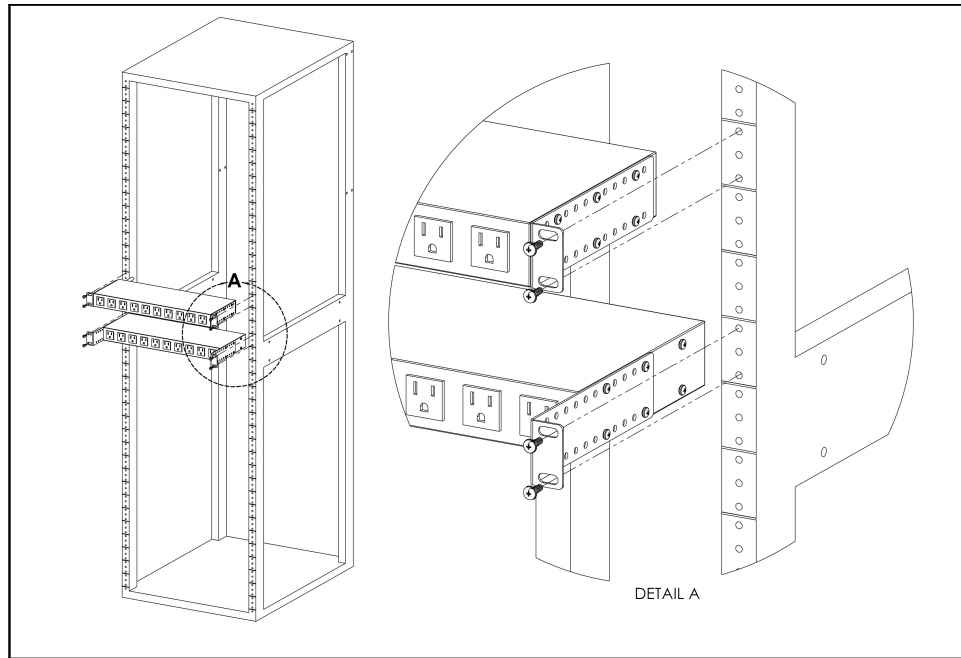

### Panel Mount Brackets (PM)

Figure 2-11 Panel Mount Brackets

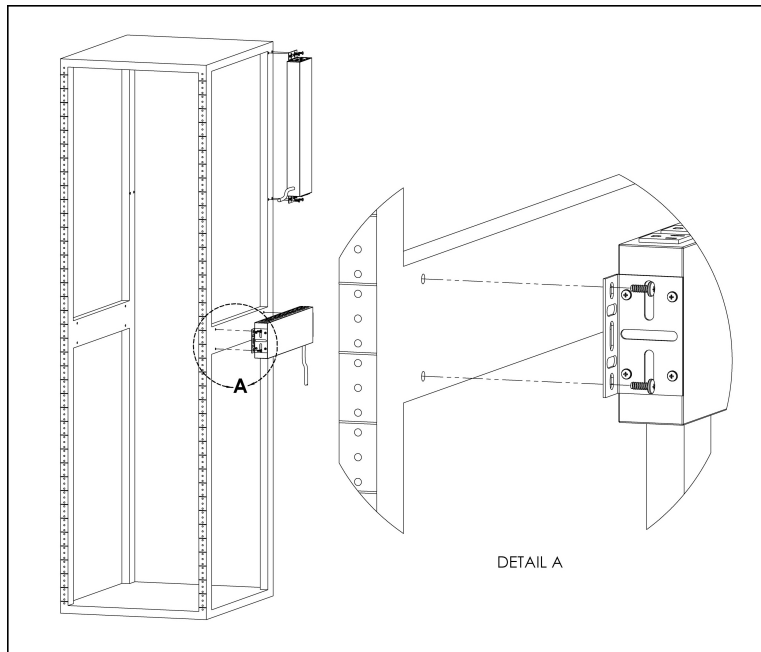

## 23" Conversion Mounting Brackets (23-RM)

Figure 2-12 23" Conversion Mounting Brackets

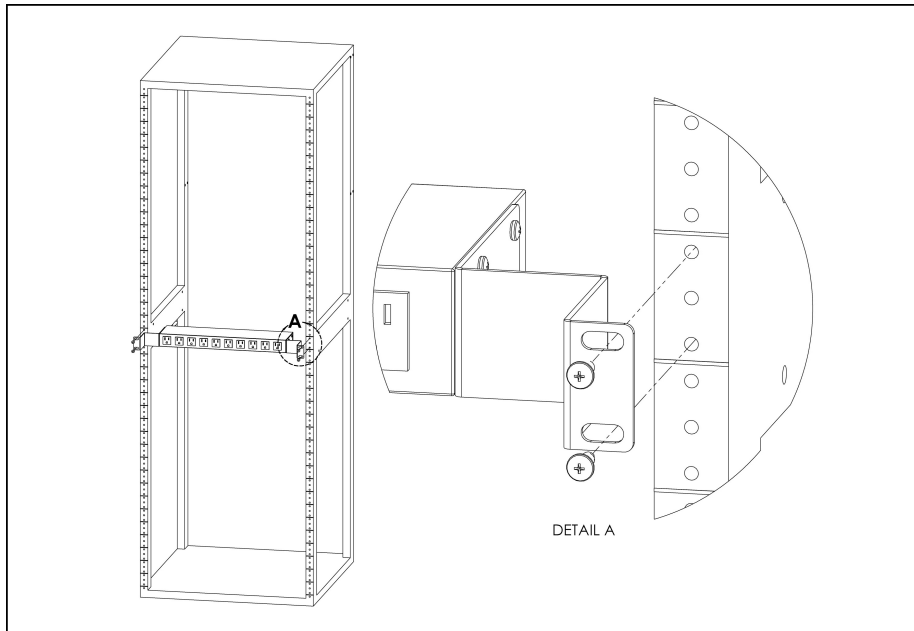

## Cable Mount Brackets (CMB-1)

Figure 2-13 Cable Mount Brackets

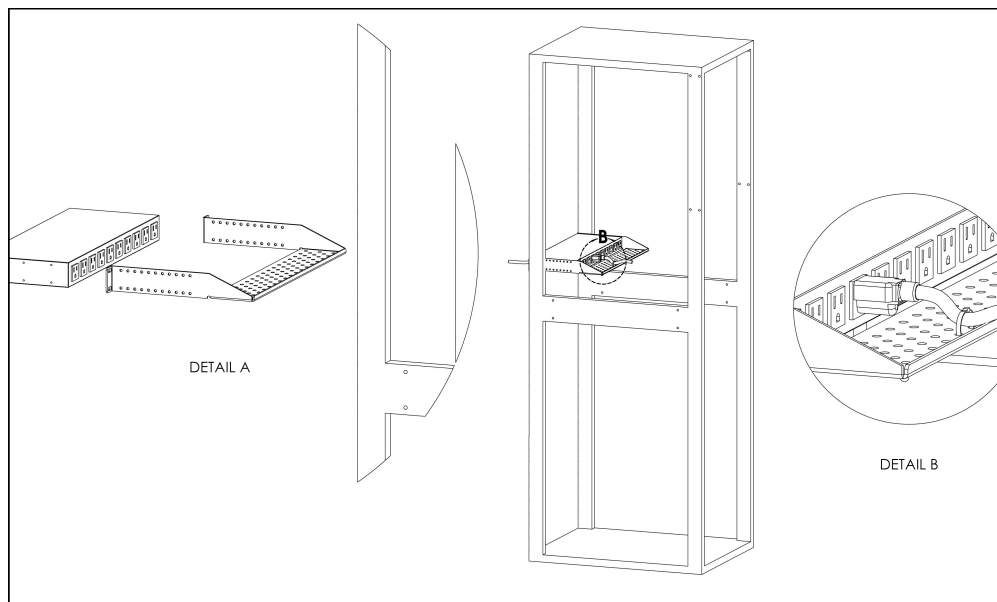

### 19" Horizontal/Panel Mount Brackets (7938)

Figure 2-14 19" Horizontal/Panel Mount Brackets

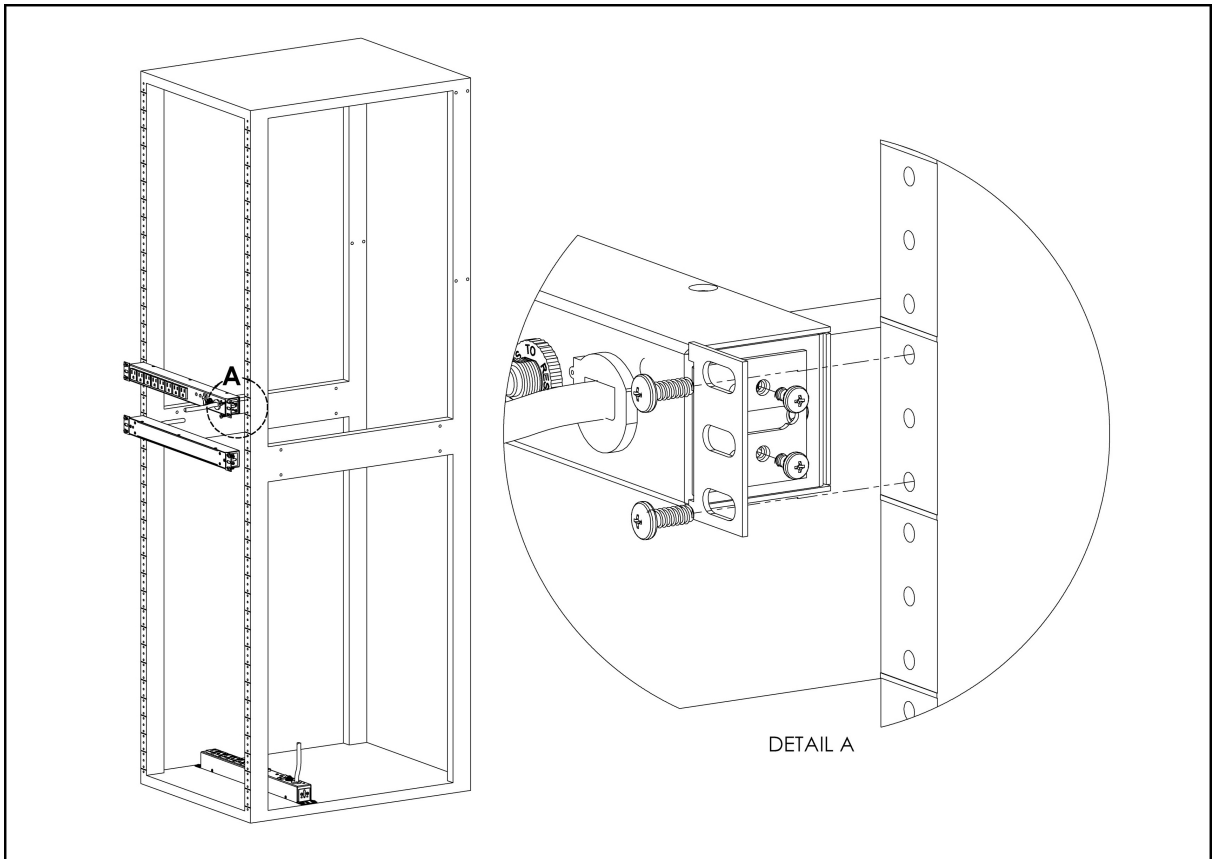

## Network Setup

The Geist R-Series PDU has a default IP address for initial setup and access. Once you have assigned an IP address, the default IP address will no longer be active. To restore the default IP address and reset all user-account information, if the user-assigned address or passwords are lost or forgotten, press and hold the network-reset button located below the Ethernet port for 15 seconds. Holding the center button of the LED display for 10 seconds will also reset the network and user account information.

To completely erase ALL of the user settings and restore the unit back to its factory-default state, disconnect power from the PDU, then press and hold the network-reset button while powering up the PDU.

The Network page (located under the System Tab) allows you to assign the network properties manually, or use DHCP to connect to your network. Access to the unit requires the IP address to be known. Use of a static IP or a reserved DHCP is recommended. The default address is shown on the front of the unit:

Table 2-1 Default IP Address

IP Address:	192.168.123.123
Subnet Mask:	255.255.255.0
Gateway:	192.168.123.1

To access the unit for the first time, you will need to temporarily change your computer's network settings to match the 192.168.123. xxx subnet. To set up the unit, connect it to your computer's Ethernet port, then follow the appropriate instructions for your computer's operating system.

### Windows

- **Windows 2000 / XP / Server 2003:**

Click the **Start** button, choose **Settings**, then **Network Connections**.

- **Windows 7 / Server 2008:**

Click the **Start** button, then choose **Control Panel >> Adjust Your Computer's Settings >> View Network Status and Tasks >> Change Adapter Settings**.

(Alternatively, on some Windows 7 machines, this may be **Start**, then **Settings >> Control Panel >> Network and Sharing Center >> Change Adapter Settings**.)

- **Windows 8 / Server 2012:**

Move the mouse cursor to the bottom or top right corner of the screen, click the **Settings** icon, then select **Control Panel**. Change the view type from **Category** to **Large** or **Small Icons** if necessary, then select **Network and Sharing Center**, then **Change Adapter Settings**.

- **Windows 10:**

Click the **Start** button, then choose **Network & Internet**, then click **Change adapter options**.

Locate the entry under **LAN or High-Speed Internet** or **Local Area Connection** which corresponds to the network card (NIC).



**NOTE**

Most computers will have a single Ethernet NIC installed, but a WiFi or 3G adapter will also show as a NIC in this list, so be sure to choose the correct entry.

Double-click on the network adapter's entry in the **Network Connections** list to open its status dialog box, then click the **Properties** button to open the **Local Properties** window.

Figure 2-15 Local Area Connection Properties

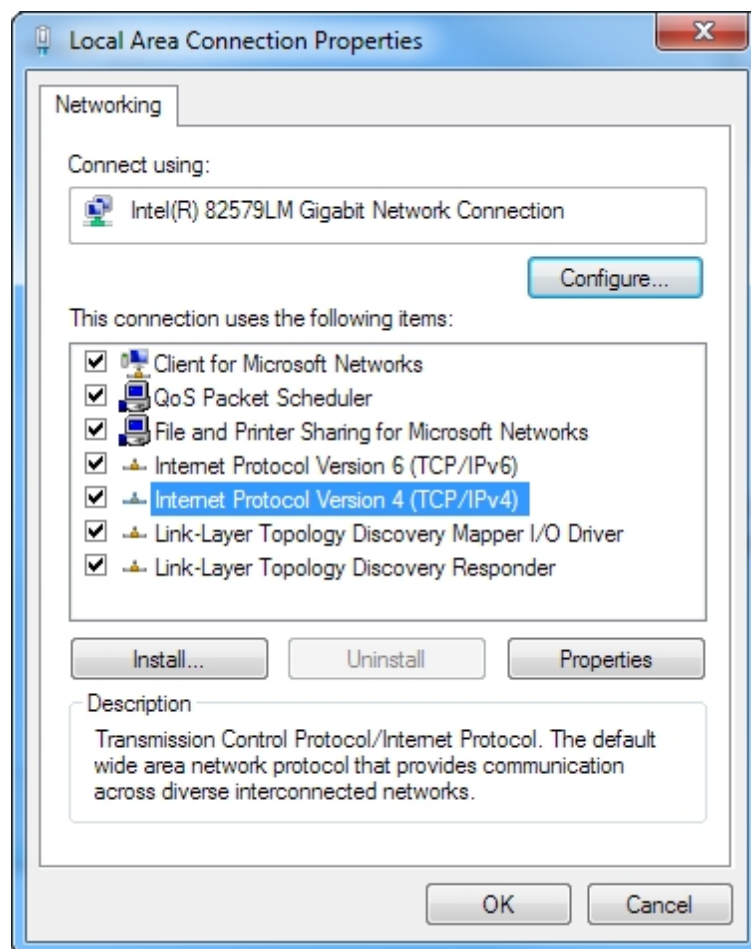

Find the entry titled "**Internet Protocol Version 4 (TCP/IPv4)**" in the list, then click the **Properties** button to open the **Internet Protocol Properties** window. If you see more

than one TCP/IP entry, as in the example above, the computer may be configured for IPv6 support as well as IPv4; make sure to select the entry for the IPv4 protocol. Write down the current NIC card settings so you can restore them to normal after you have completed the setup procedure.

Figure 2-16 Internet Protocol Version 4

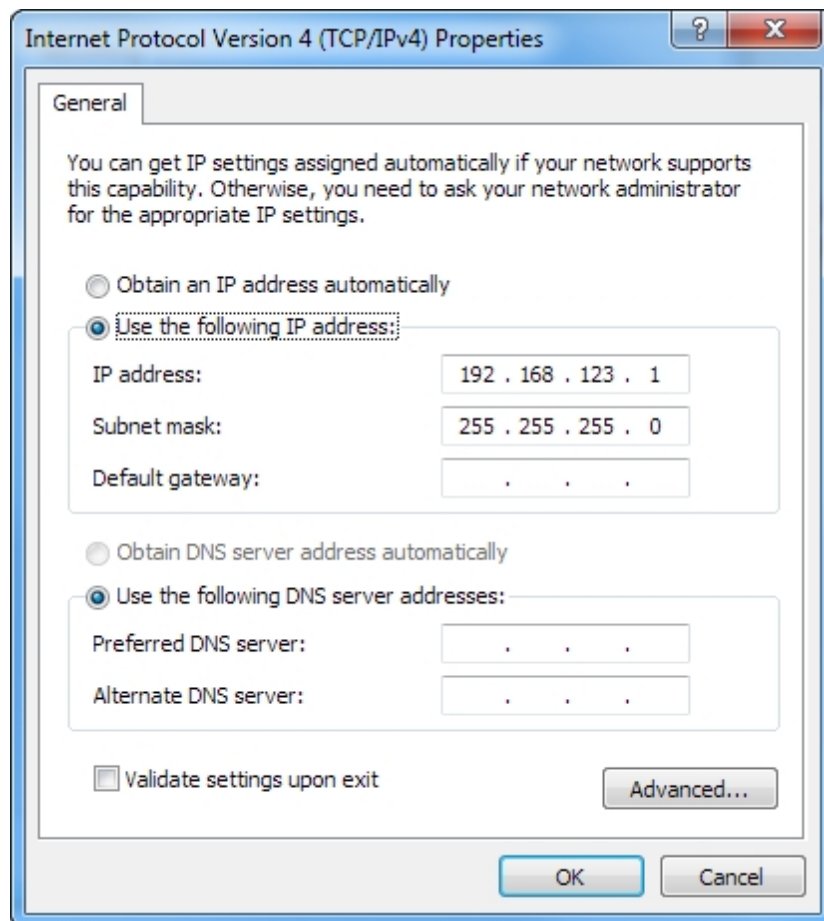

Choose the **Use the following IP address** option, then set **IP address** to 192.168.123.1 and **Subnet Mask** to 255.255.255.0. For this initial setup, **Default Gateway** and the **DNS Server** entries can be left blank. Select **OK**, then **OK** again to close both the **Internet Protocol Properties** and **Local Properties** windows.

Once the NIC settings are configured properly, you should be able to access the unit by typing `http://192.168.123.123` into the address bar of your web browser. If you are setting up the unit for the first time, or if the unit has been reset back to factory defaults via the network-reset button, the unit will require you to create an Admin account and password before you can proceed.

Once you have created an Admin account and have logged into it, the unit's default **Sensors** page should come up by default. Navigate to the **System** tab, then the **Network**

page to configure the device's network properties. The unit's IP Address, Subnet Mask, Gateway, and DNS settings can either be assigned manually, or acquired via DHCP.

Note that the new settings will take effect when the **Save** button is clicked. The browser will no longer be able to reload the web page from the 192.168.123.123 address and will probably display a "page not found" or "host unavailable" message. This behavior is normal. Once you have finished configuring the unit's IP address, simply repeat the steps above, and change the computer's Ethernet NIC card settings back to the ones you wrote down prior to changing them, to restore its normal network and internet settings.

## Mac

Click the **System Preferences** icon on the Dock, and choose **Network**.

Figure 2-17 Mac System Preferences

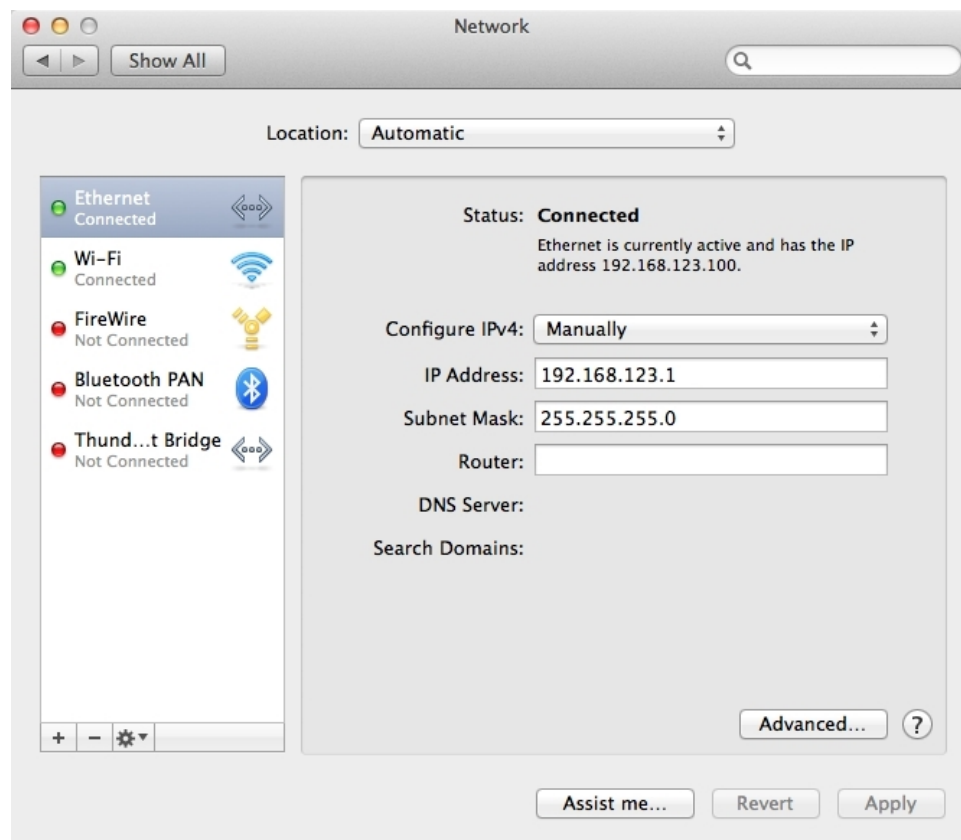

Be sure **Ethernet** is highlighted on the left side of the NIC window. In most cases, there will be one Ethernet entry on a Mac. Write down the current settings so you can restore them to normal after you have completed the setup procedure.

Select **Manually** from the **Configure IPv4** drop-down list, then set **IP Address** to 192.168.123.1 and **Subnet Mask** to 255.255.255.0. (The **Router** and **DNS Server** settings can be left blank for this initial setup.) Click **Apply** when finished.

Once the NIC settings are configured properly, you should be able to access the unit by typing `http://192.168.123.123` into the address bar of your web browser. If you are setting up the unit for the first time, or if the unit has been reset back to factory defaults via the network-reset button, the unit will require you to create an Admin account and password before you can proceed.

Once you have created the Admin account and logged into it, the unit's default **Sensors** page should come up by default. Navigate to the **System** tab, then the **Network** page to configure the device's network properties. The unit's IP Address, Subnet Mask, Gateway, and DNS settings can either be assigned manually, or acquired via DHCP.

The new settings will take effect when the **Save** button is clicked, so the browser will no longer be able to reload the web page from the 192.168.123.123 address and will probably display a "page not found" or "host unavailable" message. This behavior is normal. Once you have finished configuring the unit's IP address, simply repeat the steps above, and change the computer's Ethernet NIC card settings back to the ones you wrote down prior to changing them, to restore its normal network and internet settings.



## Chapter 3 - Setup

### Hardware Interface

The R-Series PDUs have advanced features to support data center needs for full remote monitoring, logging and alarms, with options for outlet level monitoring and switching control. The PDUs support multiple I/O options.

Figure 3-1 RCU-OD Interface

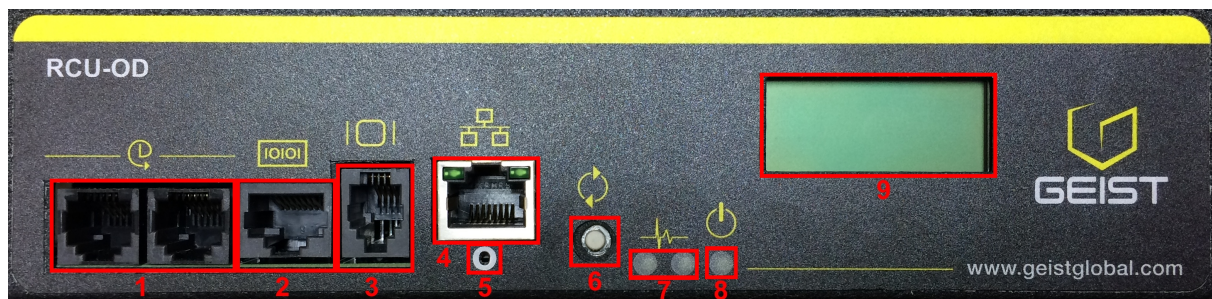

1. **Remote Sensor Port** (🔌): Two RJ12 ports for connecting Geist plug-and-play remote sensors (sold separately). Splitters may be used to increase the amount of sensors. Each sensor has a unique serial number and is automatically discovered. R-Series PDUs support up to sixteen sensors.
2. **Serial Communication Port** (📡): This RS-232 via RJ-45 port enables the R-Series PDUs to provide serial access to the command line interface.
3. **Remote Display Port** (📺): An optional remote display (RSD2X8) can be connected to the R-Series PDU.
4. **Ethernet Port** (🌐): RJ45 port for connecting the PDU to a TCP/IP network.
5. **Network-Reset Button** (🔄): Holding the network-reset button for 5 seconds during normal operation will restore the default IP address and reset the user accounts.
6. **Hard-Reset Button** (🔄): Pressing the hard-reboot button reboots the monitoring device. This acts as a power-cycle for the device, and does not change or remove any user information. Note that this will NOT affect power to the outlets.
7. **Activity/Idle LEDs** (🔌)
8. **Power Status LED** (🔌)
9. **Local LCD Display**: The local display scrolls through the values of the measurements selected on the LCD Display page.

For R-Series Switched PDUs, there is an LED next to each outlet providing feedback for the current state.

- Green: Outlet is on.
- Red: Outlet is off.

## Web Interface

The Geist R-Series PDUs come with an embedded web interface. The unit is accessible via a standard, unencrypted HTTP connection, or via an encrypted HTTPS (SSL) connection.



### **NOTE**

An administrator account (username and password) must be created when logging onto the device for the first time.

# Sensors

## Overview

The Sensors Overview page displays the PDU's data. R-Series PDUs measure power, voltage, current and energy. Readings on the Overview page are provided in real-time for all of the unit's measurements.

Figure 3-2 RCU-OD Sensor Page

State	Label	Energy (kWh)	Real Power (W)	Apparent Power (VA)	Power Factor (%)	Voltage (V <sub>RMS</sub> )	Voltage Min (V <sub>RMS</sub> )	Voltage Max (V <sub>RMS</sub> )	Current (A <sub>RMS</sub> )	Current Min (A <sub>RMS</sub> )	Current Max (A <sub>RMS</sub> )
	Total	0.938	42	43	98						
	Phase AB	0.250	17	18	93	208.0	206.8	208.5	0.09	0.08	0.09
	Phase BC	0.400	13	13	100	207.9	206.7	208.4	0.06	0.06	0.07
	Phase CA	0.288	12	12	100	209.5	208.6	210.0	0.06	0.06	0.06

State	Label	Current (A <sub>RMS</sub> )	Current Min (A <sub>RMS</sub> )	Current Max (A <sub>RMS</sub> )
	Line A	0.31	0.31	0.32
	Line B	0.32	0.32	0.33
	Line C	0.11	0.11	0.11

State	Label	Energy (kWh)	Real Power (W)	Apparent Power (VA)	Power Factor (%)	Voltage (V <sub>RMS</sub> )	Voltage Min (V <sub>RMS</sub> )	Voltage Max (V <sub>RMS</sub> )	Peak Voltage (V)	Current (A <sub>RMS</sub> )	Current Min (A <sub>RMS</sub> )	Current Max (A <sub>RMS</sub> )
	Circuit 1	3.562	0	0	0	209.4	206.5	209.7	298.7	0.00	0.00	0.00
✓	Outlet 1	0.282	0	0	0	209.4	206.5	209.7	298.7	0.00	0.00	0.00
✓	Outlet 2	0.608	0	0	0	209.4	206.5	209.7	298.7	0.00	0.00	0.00
✓	Outlet 3	0.786	0	0	0	209.4	206.5	209.7	298.7	0.00	0.00	0.00
✓	Outlet 4	0.247	0	0	0	209.4	206.5	209.7	298.7	0.00	0.00	0.00
✓	Outlet 5	0.236	0	0	0	209.3	206.5	209.6	295.1	0.00	0.00	0.00
✓	Outlet 6	0.585	0	0	0	209.3	206.5	209.6	295.1	0.00	0.00	0.00
✓	Outlet 7	0.236	0	0	0	209.3	206.5	209.6	295.1	0.00	0.00	0.00
✓	Outlet 8	0.582	0	0	0	209.3	206.5	209.6	295.1	0.00	0.00	0.00
	Circuit 2	6.884	0	0	0	208.3	205.1	208.8	298.6	0.00	0.00	0.00
✓	Outlet 9	0.231	0	0	0	208.3	205.1	208.8	297.1	0.00	0.00	0.00
✓	Outlet 10	1.149	0	0	0	208.3	205.1	208.8	297.1	0.00	0.00	0.00
✓	Outlet 11	0.527	0	0	0	208.3	205.1	208.8	297.1	0.00	0.00	0.00
✓	Outlet 12	1.142	0	0	0	208.3	205.1	208.8	297.1	0.00	0.00	0.00
✓	Outlet 13	1.425	0	0	0	208.3	205.1	208.8	298.6	0.00	0.00	0.00
✓	Outlet 14	0.759	0	0	0	208.3	205.1	208.8	298.6	0.00	0.00	0.00
✓	Outlet 15	1.317	0	0	0	208.3	205.1	208.8	298.6	0.00	0.00	0.00
✓	Outlet 16	0.334	0	0	0	208.3	205.1	208.8	298.6	0.00	0.00	0.00

### 1. Geist Logo

- Clicking on this logo from any page will reload the Sensor Overview page.

## 2. Sensors, System, and Help Tabs

- Mouse over to show sub-menus:

Table 3-1 Sensors, System, and Help Tabs

Sensors	System			Help
Overview	Users	Display	Syslog	Info
Alarms & Warnings	Network	Time	Admin	Support Site
Logging	Web Server	SSH	Locale	
	Reports	Email	Utilities	
	LDAP	SNMP		

## 3. Log In / Log Out

- Click to log in or log out of the unit. Note that both user-name and password are case sensitive; prohibited characters are: \$&':<>[ ] { } "+%@/ ; =?^|~',

## 4. Alarms and Warnings

- Indicates the number of Alarms and Warnings currently occurring, if any.

## 5. Device Label

- Displays the user-assigned label of this unit (see "Configuration and Operation")

## 6. Device ID

- Unique product identification. May be required for technical support.

## 7. Total and Individual Phase or Line Monitor

- Displays AC current, voltage, and power statistics for each individual phase, phase pair, and for the total of all phases combined.

## 8. Line Current

- Displays AC line current draw for 3-phase Delta PDUs.

## 9. Circuit and Outlet

- Displays AC current, voltage and power statistics for each circuit and outlet. (Outlet Level Power Monitoring and Switched Outlet Level Monitoring Only)
- Displays outlet status. (Switched and Switched Outlet Level Monitoring Only)

**NOTE**

Groupings for Total, Line and Phase Monitor will vary depending on the PDU's configuration and wiring.

**Configuration and Operation**

Configuration Icon



Operation Icon

**NOTE**

Only users with control or admin level authorizations have access to these settings.

**Device, Phase and Circuit Configuration:**

1. Click the desired Configuration icon to change the device's **Label**. **Name** is the PDU's factory name or model, and cannot be changed.
2. Once done, click **Save**.

Figure 3-3 Device, Phase and Circuit Configuration Page

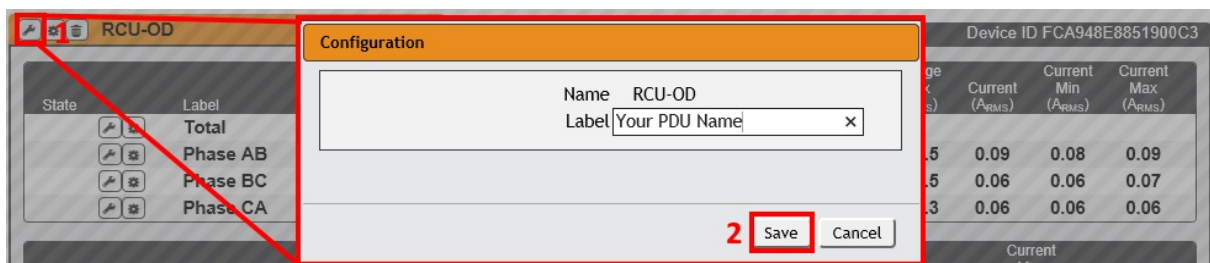

## Outlet Configuration:

1. Click the desired Outlet Configuration icon.

Figure 3-4 Outlet Configuration Page

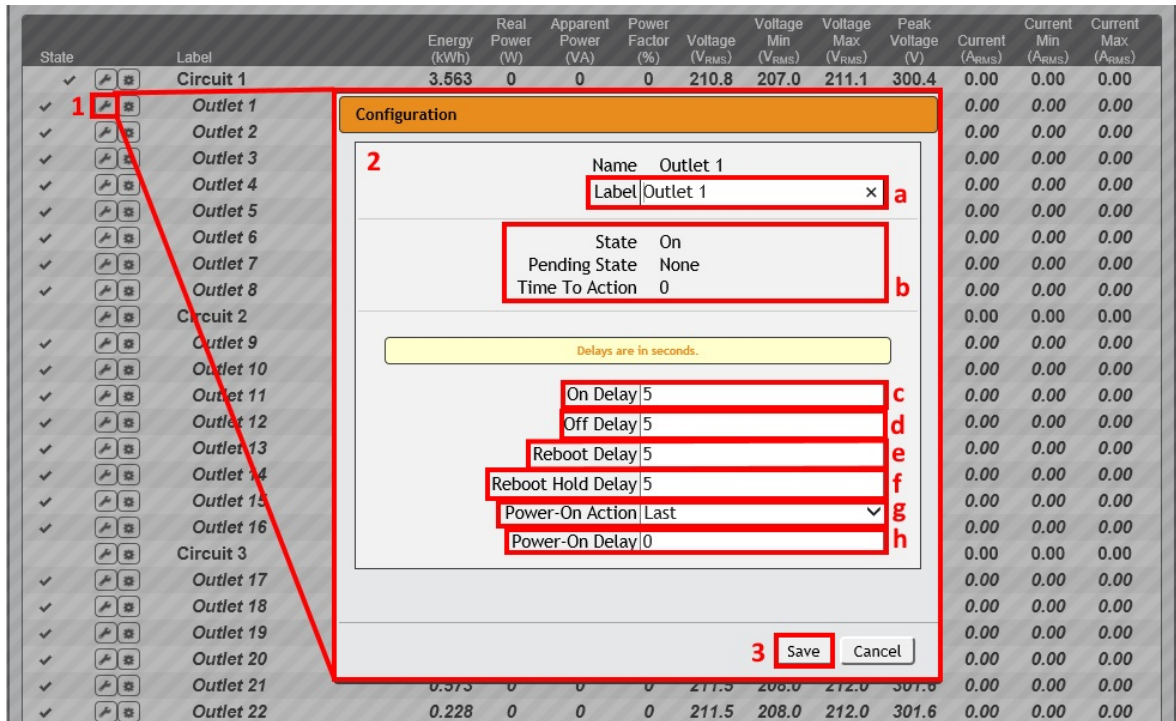

2. Configuration pop-up box will appear.
  - a. Use the text box to change the outlet's **Label**.
  - b. The outlet's state is described by three descriptors:
    - **State** describes the outlet's current state (On/Off).
    - **Pending State** describes the state the outlet is currently transitioning to, if it is in the process of switching.
    - **Time To Action** describes the time left before the pending action will take place. This is adjusted using **Delays**.
  - c. **On Delay** is the time, in seconds, the unit waits before switching an outlet on.
  - d. **Off Delay** is the time, in seconds, the unit waits before switching an outlet off.
  - e. **Reboot Delay** is the time, in seconds, the unit waits before rebooting an outlet.
  - f. **Reboot Hold Delay** is the time, in seconds, the unit waits after switching the outlet off, before switching an outlet back on during a reboot.

- g. **Power-On Action** describes the state the outlet will start at power-on (On, Off or Last).
  - h. **Power-On Delay** is the time, in seconds, the unit waits after power-on before performing the power-on action for the outlet.
3. Click the **Save** button if any settings are changed.

### Device Operation:

1. Click the Operation icon.

Figure 3-5 Device Operation Page

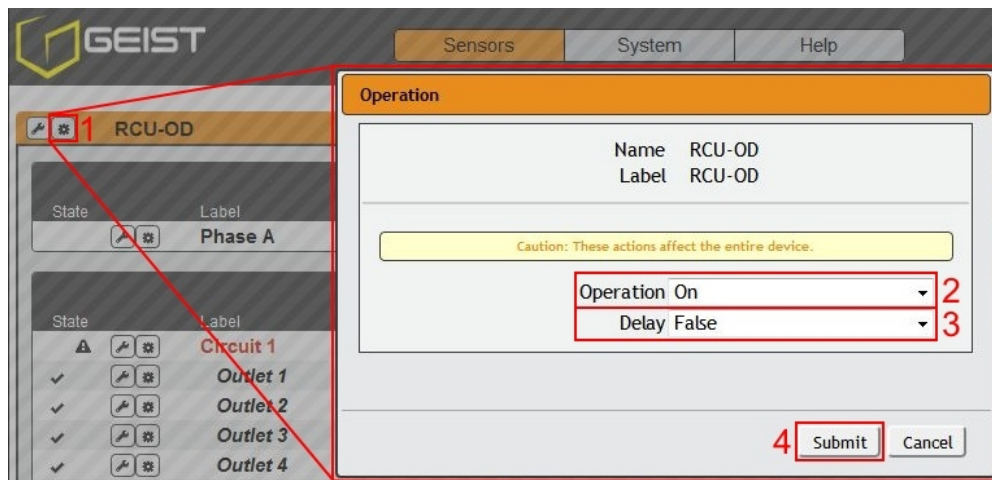

2. Select the operation you wish to perform:
  - **On/Off** turns on/off all outlets.
  - For outlets currently on, **Reboot** cycles the outlets off, then back on after the reboot hold delay. For outlets currently off, **Reboot** turns the outlets on.
  - **Cancel** will cancel the current operation if it has not been completed yet.
  - **Reset Energy** will reset the total Energy measured in kWh.



**CAUTION**

These actions affect the entire device.

- For operations involving the state of the outlets, setting **Delay** to True will use the current **Delay** configuration for each outlet when performing the selected operation.
- Select **Submit** to issue the action.



**NOTE**

Power-on action delays reference the time since the unit was plugged in, not the time since it fully booted. They may execute before the unit fully boots.

### Phase/Circuit Operation:

- Click the Operation icon. For Phase/Circuit operation only the Reset Energy (kWh) operation is available.
- Click the **Submit** button to reset the energy of the Phase/Circuit.

Figure 3-6 Phase/Circuit Operation Page

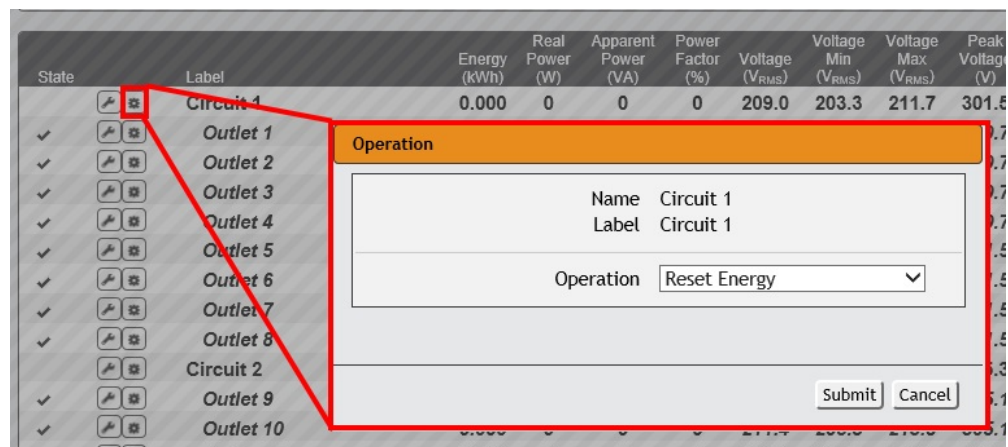

The screenshot displays a table with columns for State, Label, Energy (kWh), Real Power (W), Apparent Power (VA), Power Factor (%), Voltage (V<sub>RMS</sub>), Voltage Min (V<sub>RMS</sub>), Voltage Max (V<sub>RMS</sub>), and Peak Voltage (V). The table lists Circuit 1 and its outlets (Outlet 1 through Outlet 8), and Circuit 2 and its outlets (Outlet 9 and Outlet 10). A red box highlights the 'Operation' icon in the State column for Circuit 1. A modal dialog titled 'Operation' is open, showing the Name and Label as 'Circuit 1' and the Operation dropdown set to 'Reset Energy'. The dialog includes 'Submit' and 'Cancel' buttons.



## Outlet Operation:

1. Click the desired Outlet Operation icon.

Figure 3-7 Outlet Operation Page

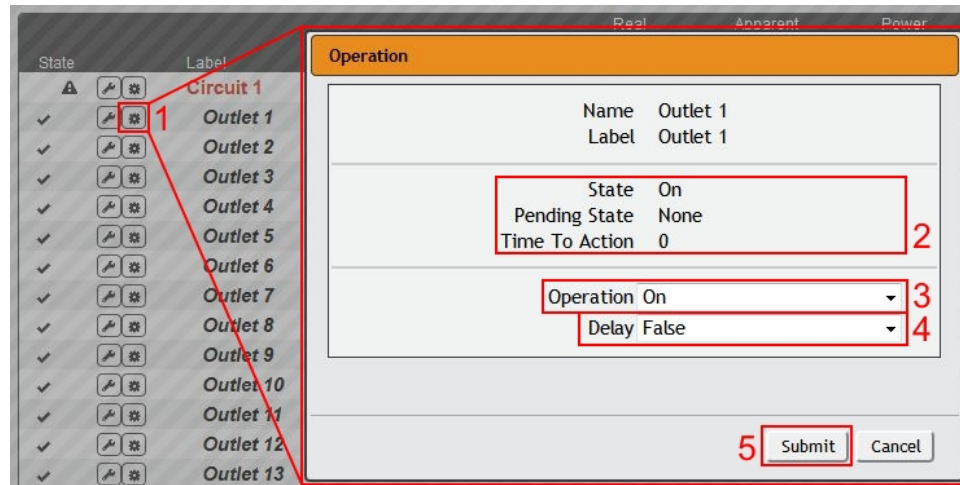

2. The outlet's state is described by three descriptors:
  - **State** describes the outlet's current state (On/Off).
  - **Pending State** describes the state the outlet is currently transitioning to, if it is in the process of switching.
  - **Time To Action** describes the time left before the pending action will take place. This is adjusted using **Delays**.
3. Select the operation you wish to perform:
  - **On/Off** turns on/off the selected outlet.
  - For an outlet currently on, **Reboot** cycles the outlet off, then back on after the reboot hold delay. For an outlet currently off, **Reboot** turns the outlet on.
  - **Cancel** will cancel the current operation if it has not been completed yet.
  - **Reset Energy** will reset the total Energy measured in kWh for the selected outlet.
  - **Reset Min Max Values** will reset Min and Max values for Voltage and Current
4. For operations involving the state of the outlet, setting **Delay** to True will use the current **Delay** configuration for each outlet when performing the selected operation. Delays are configured in "Outlet Configuration".
5. Select **Submit** to issue the action.

## Alarms & Warnings

The Alarms & Warnings page allows users to establish alarm or warning conditions (hereafter referred to as "Events") for each power, circuit and outlet readings. Events are triggered when a measurement exceeds a user-defined threshold, either going above the threshold ("high-trip") or below it ("low-trip"). Events are displayed in different sections, based on the device or measurement the Event is associated with. Each Event can have one or more Actions to be taken when the Event occurs.

Figure 3-8 Alarms & Warnings Page

State	Label	Trigger	Severity	Type	Value	Valid Time	Notify
▲	RCU-OD Circuit 1	Voltage	Alarm	High	115	—	[0]

1. **State:** Shows the status of each Event.

- Empty: No alert condition.
- ⚠ : This symbol indicates that this particular "Warning" Event has been tripped. A tripped Warning Event displays in orange.
- ▲ : This symbol indicates that this particular "Alarm" Event has been tripped. A tripped Alarm Event displays in red.
- ✓ : This symbol will indicate that this Event has not yet been acknowledged by a user after being tripped. It will remain this way until the condition being measured by this Event returns to normal (i.e. ceases to exceed the trigger threshold for this Event.) or the user has clicked the button to acknowledge the Event.

2. **Configuration:** Add/Delete/Modify Alarms & Warnings.

- ➕ : Add new Alarms & Warnings.
- 🔧 : Modify existing Alarms & Warnings.
- 🗑 : Delete existing Alarms & Warnings.

3. **Notification:** Notify user of tripped Events, and request acknowledgment.

- Empty: If the  is not present, it means that no alert condition is present or the Event has been acknowledged.
- : Acknowledge button. When a Warning or Alarm Event has occurred; the user can click on this symbol to acknowledge the Event and stop the unit from sending any more notifications about it.



## NOTE

Clicking this symbol does not clear the Warning or Alarm Event, it just stops the notifications from repeating and removes it from the active Event list.

4. The actual conditions for the various Alarms & Warnings settings are shown here.

### Alarms & Warnings Configuration

#### To add a new Alarm or Warning Event:

1. Click the Add/Modify Alarms & Warnings button:

Figure 3-9 Add/Modify Alarms & Warnings Page

The screenshot shows the 'Alarms & Warnings' configuration interface. A modal window titled 'Add' is open, allowing the user to create a new event. The form includes the following fields and options:

- Name:** RCU-OD (labeled 'a')
- Trigger:** (state) (labeled 'b')
- Severity:** Alarm (labeled 'c')
- Type:** Status (labeled 'd')
- Threshold Value:** (labeled 'e')
- Clear Delay:** 0 (labeled 'f')
- Trip Delay:** 0 (labeled 'g')
- Latching Mode:**  (labeled 'h')
- Valid Time:** Always (labeled 'i')
- Invert Valid Time:**  (labeled 'j')
- Table:**

Enabled	+	Target	Delay	Repeat
<input type="checkbox"/>		username@server.com	1	1

At the bottom right of the modal, there are 'Save' (labeled '3') and 'Cancel' buttons.

2. Set the desired conditions for this Event as follows:

- Select the **Name** of the phase or circuit you wish to set an Event on.
- Select the measurement (current, voltage, etc.) you want to **Trigger** the Event.
- Set the **Severity** level ("Warning", or "Alarm") for this Event.
- Select the threshold **Type**, "Status" (trips if device status changes), "high" (trips if the measurement goes above the threshold) or "low" (trips if the measurement goes below the threshold).

- e. Type in the desired **Threshold Value** (any number between -999.0 ~ 999.0 is valid).
- f. Type in the desired **Clear Delay** time in seconds. Any value other than "0" means that once this Event is tripped, the measurement must return to normal for this many seconds before the Event will clear and reset. Clear Delay can be up to 14400 seconds (4 hours).
- g. Type in the desired **Trip Delay** time in seconds. Any value other than "0" means that the measurement must exceed the threshold for this many seconds before the Event will be tripped. Trip Delay can be up to 14400 seconds (4 hours).
- h. **Latching Mode**: If enabled, this Event and its associated Actions (see Figure 3-10) remain active until the Event is acknowledged, even if the measurement subsequently returns to normal.
- i. **Valid Time** decides when an Alarm notification can be sent. **Valid Time** is set by clicking the Add/Modify icon and setting the days and time ranges notifications will be sent. Then clicking **Save**.



## NOTE

Only one valid time can be selected per alarm.

Figure 3-10 Add Event Time

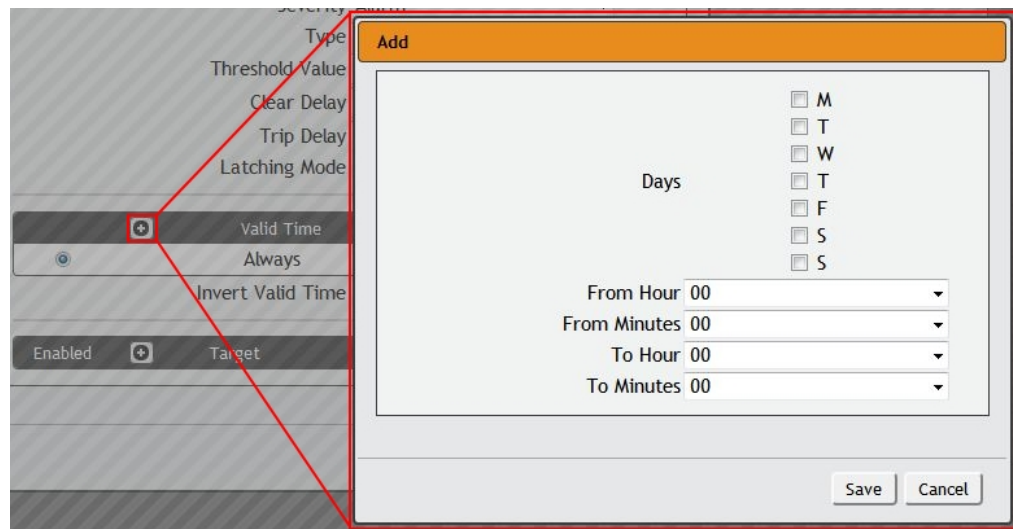

- j. The **Invert Valid Time** check box inverts the selected **Valid Time** setting.

- k. To determine where the alert notifications will be sent to when this particular Alarm or Warning Event occurs, click the Add icon to create a new Action, then select the desired options from the drop-down menu:

Figure 3-11 Add New Action

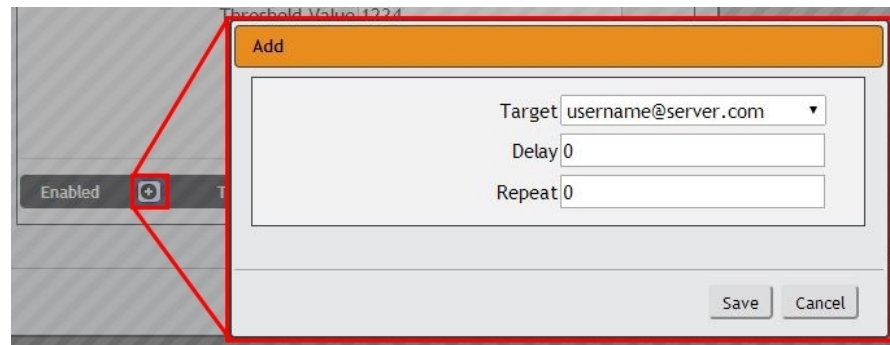

- **Target** is the e-mail address or SNMP manager to which notifications should be sent when the Event is tripped. Other options, such as "buzzer", may be available depending on your Geist PDU.
- **Delay** determines how long this Event must remain tripped before this Action's first notification is sent. (Note that this is different from the Trip Delay, above; Trip Delay determines how long the threshold value has to be exceeded before the Event itself is tripped.) **Delay** can be up to 14400 seconds (4 hours). A **Delay** of 0 will send the notification immediately.
- **Repeat** determines whether multiple notifications will be sent for this Event Action. **Repeat** notifications are sent at the specified intervals until the Event is acknowledged, or until the Event is cleared and reset. The **Repeat** interval can be up to 14400 seconds (4 hours). A **Repeat** of 0 disables this feature, and only one notification will be sent.

Then, click **Save** to save this notification Action.

If required, multiple Actions can be set for an Alarm or Warning; to add multiple Actions click the Add icon again and set each one as desired. Each alert can have up to 32 Actions associated with it.

To change an existing notification Action, click the Modify icon next to the Action you wish to change, then modify its settings as above.

Figure 3-12 Modify Action

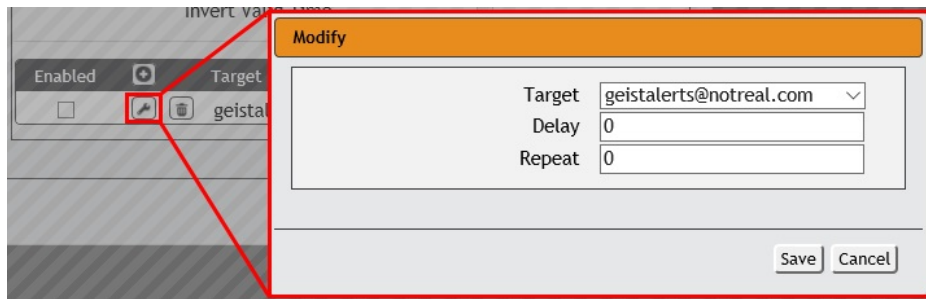

Once an Action has been added, each Action has its own checkbox in the "enabled" column at the far left. The default is unchecked (disabled) when you first add each Action; set the checkbox to enable it. (This allows you to selectively turn different Actions on and off for testing.)

To remove a notification Action entirely, click the Delete icon to remove the Action from the list, then click **Delete** to confirm:

Figure 3-13 Delete Action

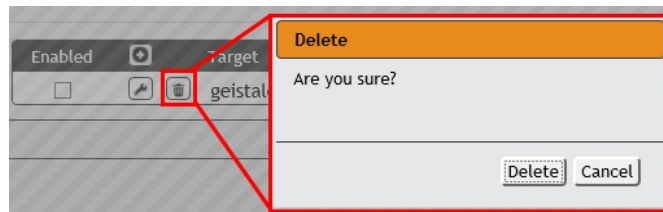

3. When finished, click **Save** to save this Alarm or Warning event.

### To change an existing Alarm or Warning Event:

Click the Modify icon next to the Alarm or Warning Event you wish to change, then modify its settings as above.

### To delete an existing Alarm or Warning Event:

Click the Delete icon next to the Alarm or Warning Event you wish to change, then click **Delete** to confirm.

## Logging

The Logging page allows the user to access the historical data recorded by the PDU by selecting the desired sensors and time range to be logged.

Figure 3-14 Logging Page

**Data Log**

1      Download the data log [JSON](#)  
 Download the data log [CSV](#)

Warning: Changing the interval clears the log.

2      Log Interval (minutes)   
Save

3      Clear the Log

**Logging**

4      Click a measurement value to select or deselect.  
Save

**RCU-OD**
Device ID D7A36BE3851900C3

State	Label	Energy (kWh)	Real Power (W)	Apparent Power (VA)	Power Factor (%)	Voltage (V <sub>RMS</sub> )	Voltage Min (V <sub>RMS</sub> )	Voltage Max (V <sub>RMS</sub> )	Current (A <sub>RMS</sub> )	Current Min (A <sub>RMS</sub> )	Current Max (A <sub>RMS</sub> )
	<b>Total</b>	193.563	21	24	88						
	Phase AB	97.166	10	13	76	217.8	211.0	219.3	0.06	0.05	0.06
	Phase BC	47.837	6	6	100	218.0	211.2	219.4	0.03	0.03	0.03
	Phase CA	48.560	5	5	100	217.0	210.6	218.6	0.02	0.02	0.03

State	Label	Current (A <sub>RMS</sub> )	Current Min (A <sub>RMS</sub> )	Current Max (A <sub>RMS</sub> )
	Line A	0.14	0.12	0.16
	Line B	0.15	0.14	0.17
	Line C	0.05	0.04	0.05

State	Label	Energy (kWh)	Real Power (W)	Apparent Power (VA)	Power Factor (%)	Voltage (V <sub>RMS</sub> )	Voltage Min (V <sub>RMS</sub> )	Voltage Max (V <sub>RMS</sub> )	Peak Voltage (V)	Current (A <sub>RMS</sub> )	Current Min (A <sub>RMS</sub> )	Current Max (A <sub>RMS</sub> )
	Circuit 1	0.000	0	0	0	210.0	203.3	211.7	301.5	0.00	0.00	0.00
✓	Outlet 1	0.000	0	0	0	209.9	203.3	211.6	300.7	0.00	0.00	0.00
✓	Outlet 2	0.000	0	0	0	209.9	203.3	211.6	300.7	0.00	0.00	0.00
✓	Outlet 3	0.000	0	0	0	209.9	203.3	211.6	300.7	0.00	0.00	0.00
✓	Outlet 4	0.000	0	0	0	209.9	203.3	211.6	300.7	0.00	0.00	0.00

### 1. Data Log Download

- Clicking on the **JSON** link will download the data log in JSON format.
- Clicking on the **CSV** link will download the data log in .csv format for use in spreadsheet software such as Microsoft Excel.

## 2. Log Interval

- Change the frequency at which data is written to the log file. The logging interval can be 1-600 minutes with the default setting being 15 minutes.



**NOTE**

Changing the log interval will result in the data log being cleared. Please download existing log data prior to changing log interval.

## 3. Clear Log Data

- Click on the Clear the Log button to delete log file.

## 4. Logging

- Click measurement value to select or deselect desired logging parameters. All measurements are selected by default.
- Press Save button to save changes



**NOTE**

Maximum loggable time frame is determined by number of measurements being logged and the interval at which data is written to the log file.

# System

## Users

The Users page in the System menu allows you to manage or restrict access to the unit's features by creating accounts for different users.

Figure 3-17 User Account Page

User Accounts				
	Username	Admin	Control	Enabled
1	guest			✓
2	Geist	✓	✓	✓
3	GeistDemo		✓	✓



There are three buttons available on the User Accounts page:

1. Add New User Account
2. Modify User's Account
3. Delete User's Account



## NOTE

Only an Administrator-level account can Add, Modify, or Delete users. Control-level and View-Only accounts can change their own passwords via the Modify button, but cannot Add or Delete accounts, or Modify other accounts. The Guest account cannot Add, Delete, or Modify any account, not even itself.

To Add a user Account:

1. Click the Add User icon.

Figure 3-18 Add User Account Page

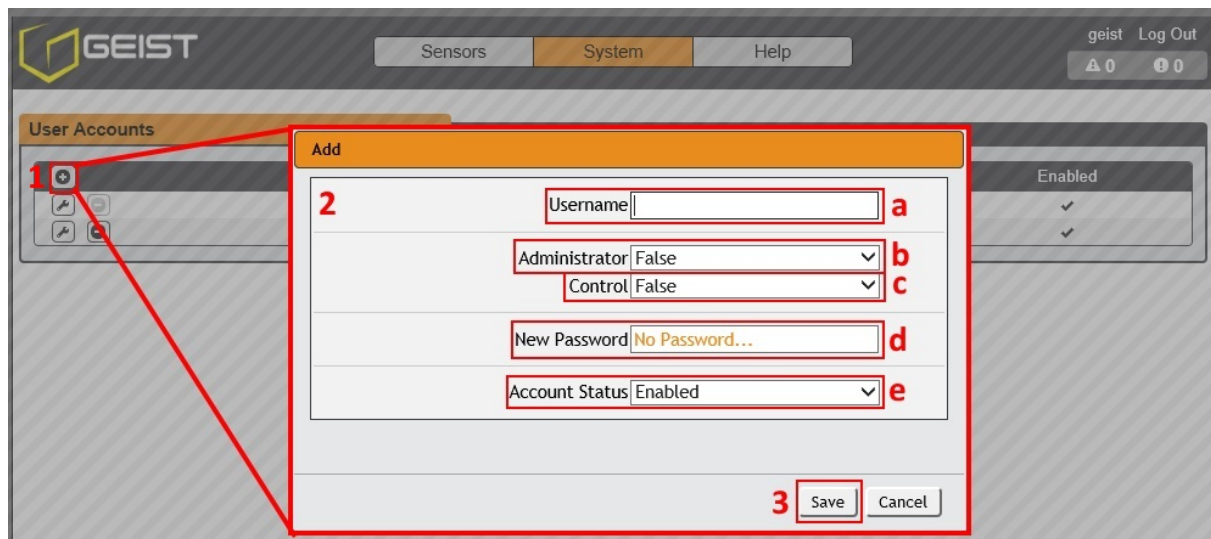

2. Create the account information as follows:

- a. **Username:** the name of this account. User names may be up to 24 characters long, are case-sensitive, and may not contain spaces or any of these prohibited characters: \$&':<>[]{}"+%@/ ; =?^|~', Note that an account's username cannot be changed after the account is created.
- b. **Administrator:** if set to True, this account has Administrator-level access to the unit, and can change any setting.

- c. **Control:** if set to True, this account has Control-level access. Setting Administrator to True will automatically set Control to True as well. Setting this to False makes the account a View-Only account.
- d. **New Password:** account passwords may be up to 24 characters long, are case-sensitive, and may not contain spaces.

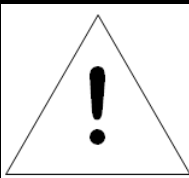

## NOTE

Strong passwords typically contain at least 8 characters with a mix of Alpha (lower and upper case), numeric, and special characters.

- e. **Account Status:** set the account to Enabled or Disabled. Disabling an account prevents it from being used to log in, but does not delete it from the account list.
3. Click the **Save** button when finished.

### Account Types:

- **Administrator:** Administrator accounts (accounts with both Administrator and Control authority set to True, as above) have full control over all available functions and settings on the device, including the ability to modify System settings and add, modify, or delete other users' accounts.
- **Control:** Control accounts (accounts with only Control set to True) have control over all settings pertaining to the device's sensors. They can add, modify, or delete Alarms & Warning Events and notification Actions, and can change the names or labels of the device and its sensors. Control accounts cannot, however, modify System settings or make changes to other users' accounts.
- **View:** If both Administrator and Control are set to False, the account is a View-Only account. The only changes a View-Only account is permitted to make are changing their own account's password, and changing the preferred language for their own account. View-Only accounts cannot change any device or system settings.
- **Guest:** Anyone who brings up the unit's web page without logging in will automatically be viewing the unit as Guest. By default, the Guest account is a View-Only account, and cannot make changes to any settings, although the Administrator can elevate the Guest account to Control-level access if desired, allowing anyone to make changes to names, labels, alarm events, and notifications without logging in. The Guest account cannot be deleted but can be disabled to require login for viewing system status.



## NOTE

Once a user has logged in to their account, they can change their password or language preference by clicking their username, shown next to the Log Out hyperlink at the top right-hand corner of the web page.

To Modify a user Account:

1. Click the Modify User icon.

Figure 3-19 Modify User Page

2. Modify the account information as follows:
  - Language preference:** Change the default language for this user. Options are English, French, Spanish, German, Portuguese, Japanese, Chinese and Korean.
  - Administrator:** if set to True, this account has Administrator-level access to the unit, and can change any setting. This option can only be modified by an Administrator level account.
  - Control:** if set to True, this account has Control-level access. Setting Administrator to True will automatically set Control to True as well. Setting this to False makes the account a View-Only account. This option can only be modified by an Administrator level account.

- d. **New Password:** account passwords may be up to 24 characters long, are case-sensitive, and may not contain spaces.



**NOTE**

Strong passwords typically contain at least 8 characters with a mix of Alpha (lower and upper case), numeric, and special characters.

- e. **Account Status:** set the account to Enabled or Disabled. Disabling an account prevents it from being used to log in, but does not delete it from the account list. This option can only be modified by an Administrator level account.
3. Click the add icon to add a user specific SSH Public Key
- Enter **Label** and **SSH Public Key** information
  - Click **Save** button when finished.

Figure 3-20 Add Icon

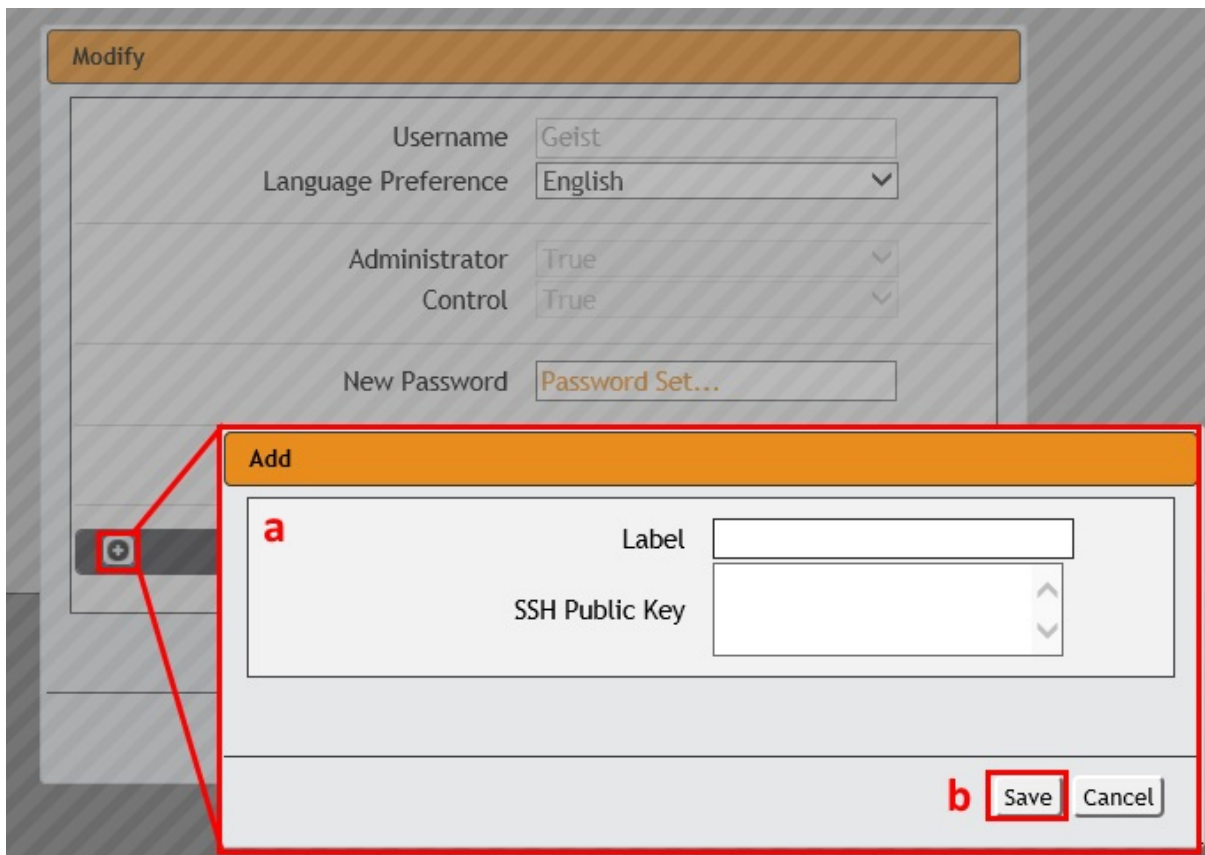

The screenshot shows a 'Modify' window with several fields: Username (Geist), Language Preference (English), Administrator (True), Control (True), and New Password (Password Set...). A red box highlights the 'Add' dialog box, which is open over the main window. The 'Add' dialog has a title bar 'Add' and contains two input fields: 'Label' and 'SSH Public Key'. A red arrow points from the '+' icon in the main window to the 'Add' dialog. At the bottom right of the 'Add' dialog, there are 'Save' and 'Cancel' buttons, with a red box around the 'Save' button and a red letter 'b' next to it.

4. Click the **Save** button when finished.

## Network

The unit's network configuration is set on the Network tab of the System menu. Settings pertaining to the unit's network connection are:

Figure 3-21 Network Configuration Page

**Hostname**

Hostname

**Interfaces**

Label	MAC Address	DHCP	Link state	Uptime
Ethernet 0	00:19:85:e3:6b:a3	Disabled	Up	597708

IP Address	Prefix
10.0.250.53	24
fe80::219:85ff:fee3:6ba3	64

**Routes**

Destination	Prefix	Gateway	Interface
default	0	10.0.250.1	all

**DNS**

DNS Server Address
208.67.222.222
208.67.220.220

- **Hostname:** The Hostname may be used as a method for device identification on the network.

- **Interfaces:** This section is used to configure the IP address of the PDU, enable/disable DHCP and to view Link State and Uptime. The device will support up to 8 user configured IP address entries.
- **Routes:** Displays configured routes and is where you will set your Gateway address for the PDU. Default routes are distinguished by a "destination" of "0.0.0.0" or ":::", with a Prefix of "0" and Interface of "all". Only one default route can exist for IPv4 and one for IPv6.
- **DNS:** Allows the unit to resolve host names for email, NTP, and SNMP servers.

Figure 3-22 Editing Interfaces Parameters

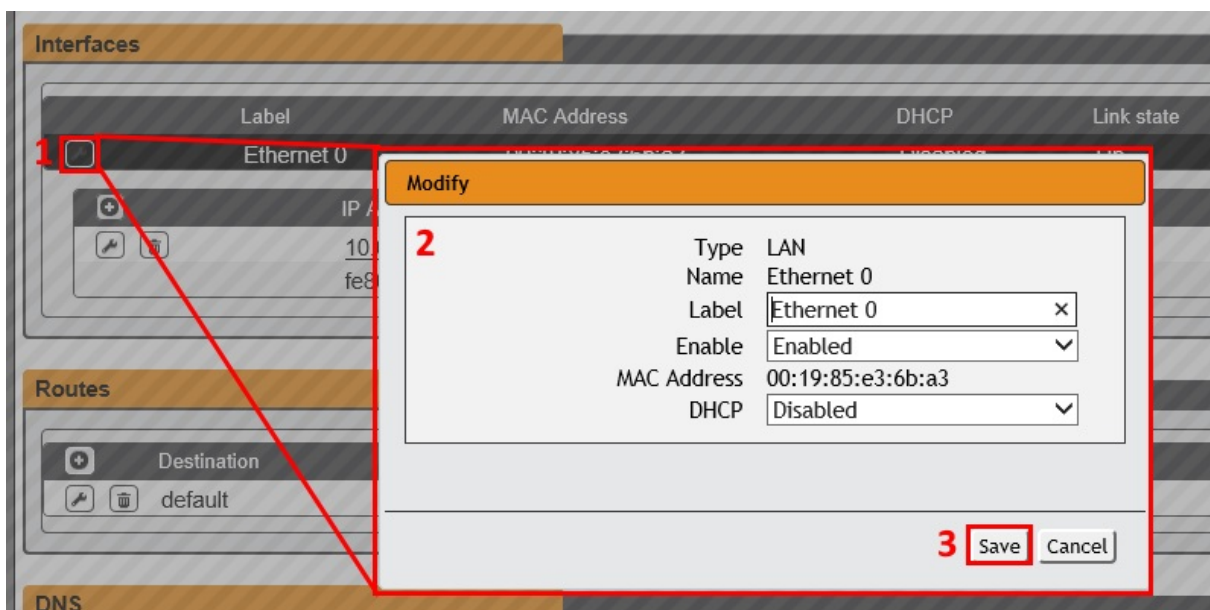

To edit the **Interfaces** parameters:

1. Click the **Modify** icon
2. Modify desired fields which include:
  - a. **Label** - Change the desired name of the selected interface.
  - b. **Enable** - Enable/Disable the selected interface. Please note that if only one interface is available/configured, disabling the interface will restrict access to the device requiring a network reset.
  - c. **DHCP** - Enable/Disable DHCP on the selected interface. DHCP is enabled by default and will be disabled if a static IP address is configured.
3. Click the **Save** button



## NOTE

Any changes you make to the Network Interface settings will take effect once the Save button is clicked! If you have changed the IP address it will appear as if the unit is no longer responding because the browser will not be able to reload the web page. Just stop or close the browser window, then type the new IP address into the browser's address bar, and the unit will be accessible.

Figure 3-23 Add New IP Address

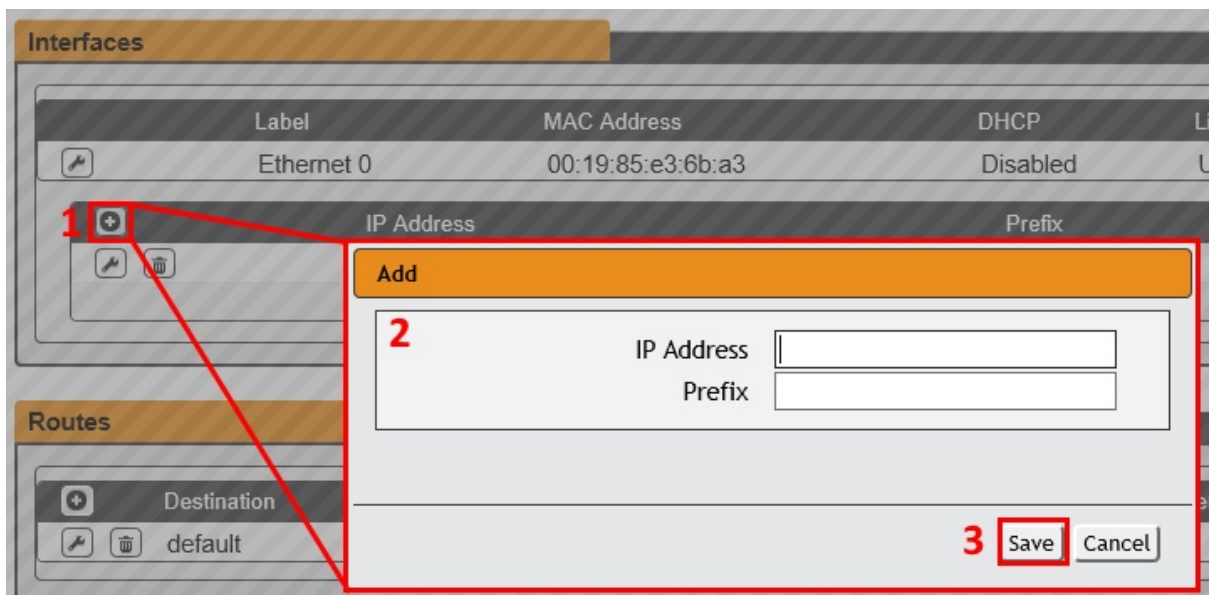

To add a new IP Address:

1. Click the **Add** icon.
2. Enter the IPv4 or IPv6 Address and Prefix/Subnet Mask into appropriate fields. Up to 8 IP addresses can be statically assigned.
3. Click the **Save** button.

Figure 3-24 Modify Existing IP Address

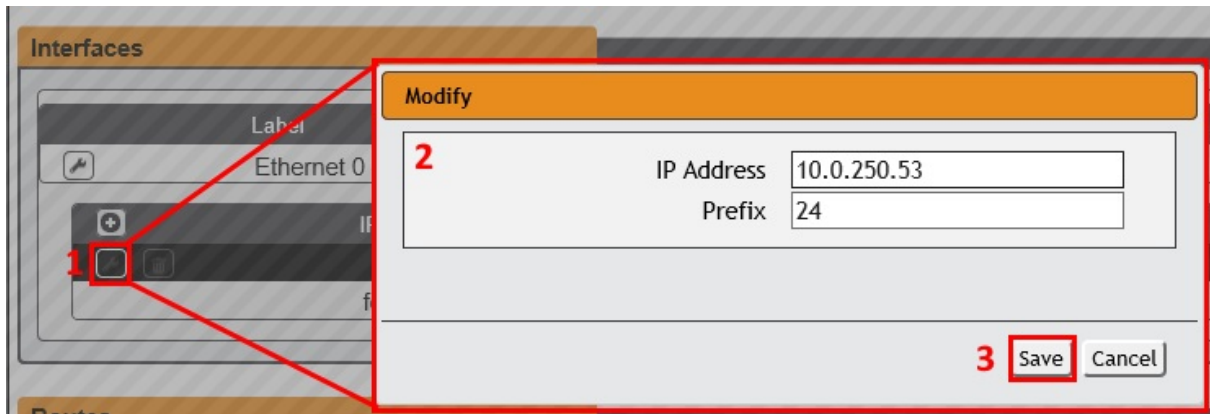

To modify an existing IP Address:

1. Click the **Modify** icon.
2. Edit the IP Address and Prefix/Subnet Mask fields as needed.
3. Click the **Save** button.

Figure 3-25 Add a New Route

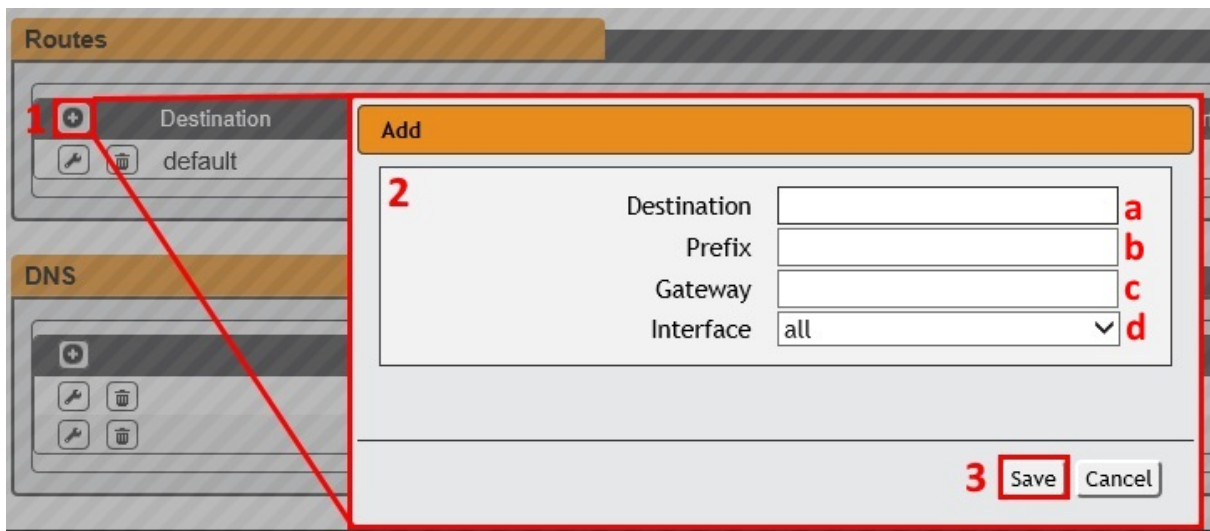

To add a new Route:

1. Click the **Add** icon.
2. Enter the appropriate information
  - a. Destination IP address for desired route
  - b. Enter Prefix for desired route



- c. Enter Gateway IP address
- d. Select Interface that route applies to

3. Click the **Save** button.

Figure 3-26 Modify an Existing Route

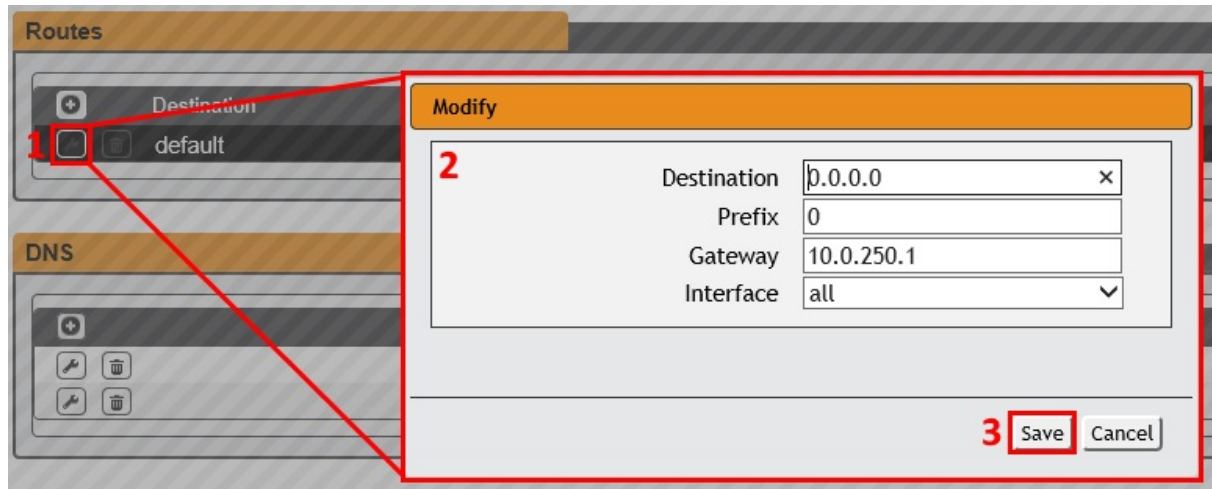

To modify an existing Route:

1. Click the **Modify** icon
2. Edit the desired fields
3. Click the **Save** button

Figure 3-27 Add a New DNS Server Address

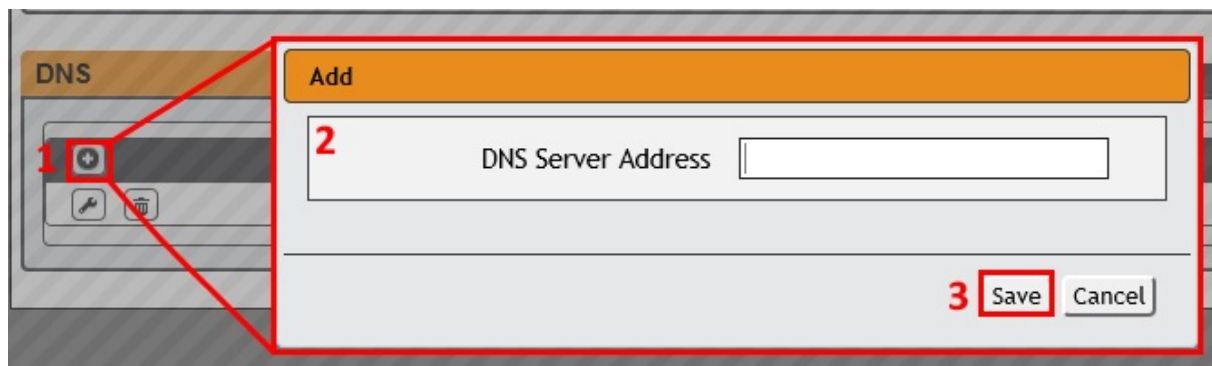

To add a new DNS Server Address:

1. Click the **Add** icon.
2. Enter the IP of the desired DNS server. Up to two DNS servers can be added.

3. Click the **Save** button.

Figure 3-28 Modify an Existing DNS Server IP Address

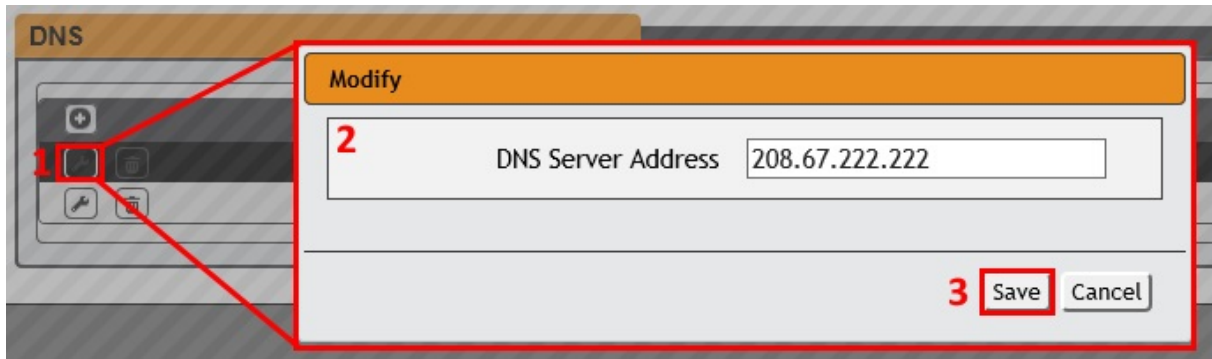

To modify an existing DNS Server Address:

1. Click the **Modify** icon
2. Edit the DNS Server Address field as required
3. Click the **Save** button

## Web Server

The unit's Web Server configuration page can be used to update Web Server information and upload self-signed SSL certificates.

Figure 3-29 Web Server Configuration Page

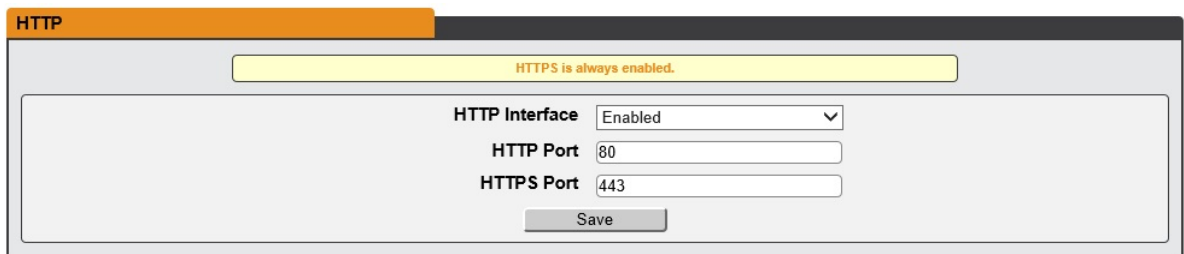

- **HTTP Interface:** Enables/disables access via HTTP. HTTPS interface will always be enabled. Available options are: Enabled or Disabled. It is not possible to disable the web interface completely.
- **HTTP/HTTPS Server Port:** Allows you to change the TCP ports which the HTTP and HTTPS services listen to for incoming connections. The defaults are port 80 for HTTP and 443 for HTTPS.

Figure 3-30 SSL Certificate Configuration Page

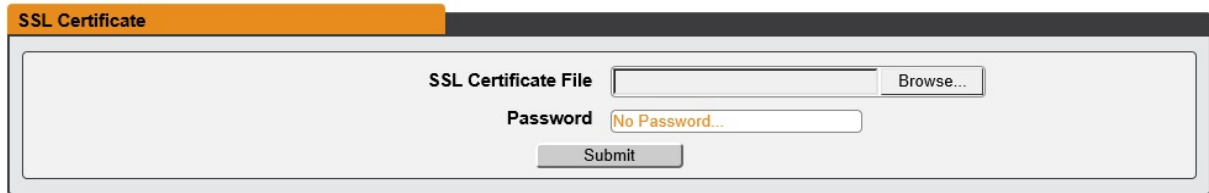

SSL Certificate

SSL Certificate File  Browse...

Password

Submit

- **SSL Certificate:** Allows you to upload your own signed SSL Certificate file to replace the default one. The certificate can be either self-signed or signed from a Certification Authority. Certificate must meet the following parameters:

Certificate must be in either PEM or PFX (PKCS12) format

- **PEM Format**

1. The public certificate and private key must reside in the same file
2. The certificate must follow standard x.509
3. The private key must be generated with the RSA algorithm and in PEM format
4. The PEM RSA private key may be password secured.

- **PFX Format**

Support is also available for the PKCS12 standard (.pfx) which is a binary encrypted combination of a PEM public certificate and its PEM private key. When generating a PFX certificate you will be prompted for an optional password.



## NOTE

If the certificate is password protected, you will need to enter that password into the GUI to upload the certificate successfully.

## Reports



The **Reports** page allows the user to schedule the device to send recurring status reports.



### NOTE

SMTP email must be set-up on the device via the Email page.

Figure 3-31 Reports Page

Reports				
	Days	Start Time	Interval (hours)	Targets
  	M-W-F--	00:00	12	[1]

### To Add or Modify a scheduled report:

1. Click the **Add** or **Modify** icon.

Figure 3-32 Add or Modify Report Schedule

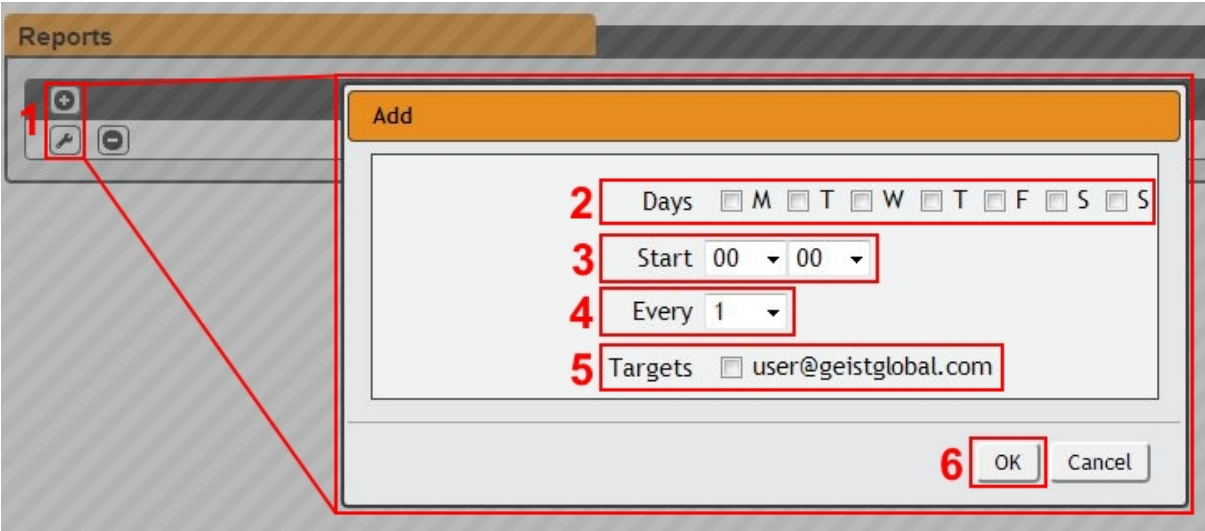

2. Select the **Days** the report is to be sent.
3. Select the time of the day to **Start** sending reports.
4. Set the interval (in hours).

5. Select the **Target** email address for the reports to be sent.
6. Click **OK** to save changes.

#### To Delete a scheduled Report:

1. Click on the **Delete** icon next to the report to delete.
2. Click the **OK** button on the pop-up window to confirm.

## LDAP

The Lightweight Directory Access Protocol (LDAP) can be setup through this menu.

Figure 3-33 LDAP Menu

The screenshot shows the LDAP configuration window with the following fields and values:

Enable	Enabled
LDAP Server Address	host
LDAP Server Port	389
LDAP Mode	Active Directory
Security Type	None
Bind DN	
Bind Password	No Password...
Base DN	
User Filter	(objectClass=posixAccount)
"uid" Mapping	uid
"uidNumber" Mapping	uidNumber
Group Filter	(objectClass=posixGroup)
"gid" Mapping	gidNumber
"memberUid" Mapping	memberOf
Enabled Group	enabled
Control Group	control
Admin Group	admin

Save

- **Enable:** Enabling or Disabling LDAP.
- **LDAP Server Address:** Specify the host address for LDAP. The "HOST" can be an IPv4 address, an IPv6 address in brackets (ie. [2001:0DB8:AC10:FE01::]), or a host name.
- **LDAP Server Port:** Used to set the LDAP port number. The default port for LDAP is 389.

- **LDAP Mode:** Available LDAP modes are Active Directory or OpenLDAP.
- **Bind Password:** Password used to bind to the directory server.
- **Base DN:** DN to use for the search base.

The remaining fields come from the NIS schema, defined in RFC2307. They are used to authenticate users in LDAP. Leaving them blank will use the default value, which is shown in the picture, in orange.

- **User Filter:** LDAP filter for selecting users.
- **"uid" Mapping:** Name of the server attribute that corresponds to the "uid" attribute in the schema.
- **"uidNumber" Mapping:** Name of the server attribute that corresponds to the "uidNumber" attribute in the schema.
- **Group Filter:** LDAP filter for selecting groups.
- **"gid" Mapping:** Name of the server attribute that corresponds to the "gid" attribute in the schema.
- **"memberUid" Mapping:** Name of the server attribute that corresponds to the "memberUid" attribute in the schema.
- **Enabled Group:** Users in this group will have access to unit and permissions based on **Control Group** and **Admin Group** settings.
- **Control Group:** Users in this group have "control" privileges as described in the *Users* section of this manual.
- **Admin Group:** Users in this group have "admin" privileges as described in the *Users* section of this manual. LDAP users do not count toward minimum number of required admin users.

## Display

The unit's display configuration can be changed via the Display tab of the System menu.

Figure 3-34 Display Page

LCD Display Config

Click a measurement value to select or deselect.

Save

RCU-OD Device ID FCA948E8851900C3

State	Label	Energy (kWh)	Real Power (W)	Apparent Power (VA)	Power Factor (%)	Voltage (VRMS)	Voltage Min (VRMS)	Voltage Max (VRMS)	Current (ARMS)	Current Min (ARMS)	Current Max (ARMS)
	<b>Total</b>	4.155	43	44	98						
	Phase AB	1.503	17	18	93	207.3	205.6	210.7	0.09	0.08	0.09
	Phase BC	1.411	13	13	100	207.2	205.5	210.6	0.06	0.06	0.07
	Phase CA	1.241	13	13	100	208.7	207.3	212.0	0.06	0.06	0.06

State	Label	Current (ARMS)	Current Min (ARMS)	Current Max (ARMS)
	Line A	0.32	0.29	0.34
	Line B	0.33	0.30	0.35
	Line C	0.11	0.11	0.11

State	Label	Energy (kWh)	Real Power (W)	Apparent Power (VA)	Power Factor (%)	Voltage (VRMS)	Voltage Min (VRMS)	Voltage Max (VRMS)	Peak Voltage (V)	Current (ARMS)	Current Min (ARMS)	Current Max (ARMS)
✓	Circuit 1	3.562	0	0	0	208.4	205.1	211.9	302.3	0.00	0.00	0.00
✓	Outlet 1	0.282	0	0	0	208.4	205.1	211.9	302.3	0.00	0.00	0.00
✓	Outlet 2	0.608	0	0	0	208.4	205.1	211.9	302.3	0.00	0.00	0.00
✓	Outlet 3	0.786	0	0	0	208.4	205.1	211.9	302.3	0.00	0.00	0.00
✓	Outlet 4	0.247	0	0	0	208.4	205.1	211.9	302.3	0.00	0.00	0.00
✓	Outlet 5	0.236	0	0	0	208.3	205.1	211.8	298.6	0.00	0.00	0.00
✓	Outlet 6	0.585	0	0	0	208.3	205.1	211.8	298.6	0.00	0.00	0.00
✓	Outlet 7	0.236	0	0	0	208.3	205.1	211.8	298.6	0.00	0.00	0.00
✓	Outlet 8	0.582	0	0	0	208.3	205.1	211.8	298.6	0.00	0.00	0.00

The Display page allows the user to configure what measurements are scrolling on the local or remote LCD display.

### To Add measurements:

1. Click the value that is desired. A highlighted value will indicate that the value will be shown on the local LCD display.
2. Click the **Save** button.

### To Remove measurements:

3. Click the highlighted value that is desired to deselect it from the display.
4. Click the **Save** button.

## Time

The unit's time and date are set on this page.

Figure 3-35 Time Configuration Page

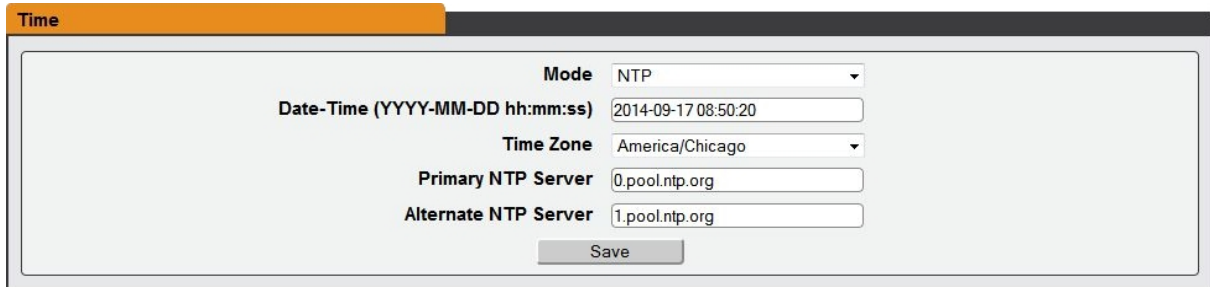

There are two mode available: **Network Time Protocol (NTP)** and **Manual**.

1. NTP synchronizes the unit's time and date to the specified time zone using listed NTP Servers. NTP servers can be reconfigured.
2. In Manual mode, the date and time must be typed as indicated on the left of the field.

## SSH

The SSH menu allows you to configure settings for SSH access to the device.

Figure 3-36 SSH Configuration Page

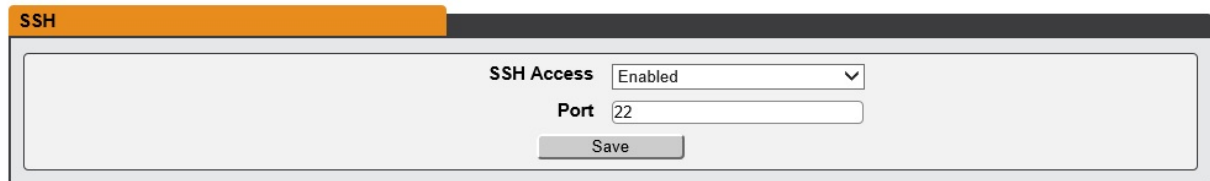

- **SSH Access:** Enables/disables access via SSH.
- **SSH Port:** Allows you to change the port which the SSH service listen to for incoming connections. The default is port 22.

## Email

The unit is capable of sending email notifications to up to ten email addresses when an Alarm or Warning Event occurs.



Figure 3-37 Email Configuration Page

Target email addresses can be configured as follows:

Figure 3-38 Email Target Address Page

Legend of icons/buttons:

1. Add new target email address.
2. Modify existing target email address.
3. Delete existing target email address.
4. Send test email.

To send emails, the unit must be configured to access the mail server, as follows:

- **SMTP Server:** The name or IP address of a suitable SMTP or ESMTP server.
- **Port:** The TCP port which the SMTP Server uses to provide mail services. Typical values would be port 25 for an unencrypted connection, or 465 and 587 for a TLS/SSL-encrypted connection, but these may vary depending on the mail server's configuration.
- **Enable SSL:** If Enabled, the unit will attempt to connect to the server using a fully-encrypted TLS/SSL connection. When this setting is enabled only fully-encrypted

sessions are supported; the "StartTLS" method, where the session starts out as unencrypted and then switches to encrypted partway through the session, is not supported. If using a service that utilizes StartTLS, such as Office365, please leave this option Disabled.

- **"From" Email Address:** The address which the unit's emails should appear to come from. Many hosted email services, such as Gmail, will require this to be the email account of a valid user.
- **Username and Password:** The login credentials for the email server. If your server does not require authentication (open relay), these can be left blank.

Microsoft Exchange servers will have to be set to allow SMTP relay from the IP address of the unit. In addition, the Exchange server will need to be set to allow "Basic Authentication", so that the unit will be able to log in with the AUTH LOGIN method of sending its login credentials. Other methods, such as AUTH PLAIN, AUTH MD5, etc. are not supported.

Figure 3-39 Email Target Configuration Page

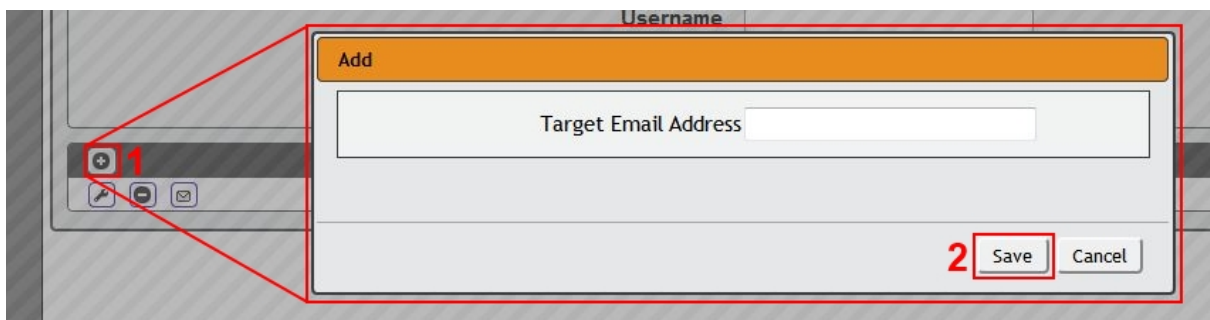

#### To Add or Modify a Target Email address:

1. Click on the Add or Modify icon.
2. Type email address and then click **Save**.

#### To Delete a Target Email address:

1. Click on the Delete icon next to the address you wish to delete.
2. Click the **Delete** button on the pop-up window to confirm.

#### To send a test email:

1. Click on the Test Email icon next to the address you wish to test.
2. A pop-up window will indicate that the test email is being sent. Click **OK** to dismiss the pop-up.

## SNMP

Simple Network Management Protocol (SNMP) can be used to monitor the unit's measurements and status, if desired. SNMP v1, v2c and v3 are supported. In addition,

alarm traps can be sent to up to two IP addresses.

Figure 3-40 SNMP Configuration Page

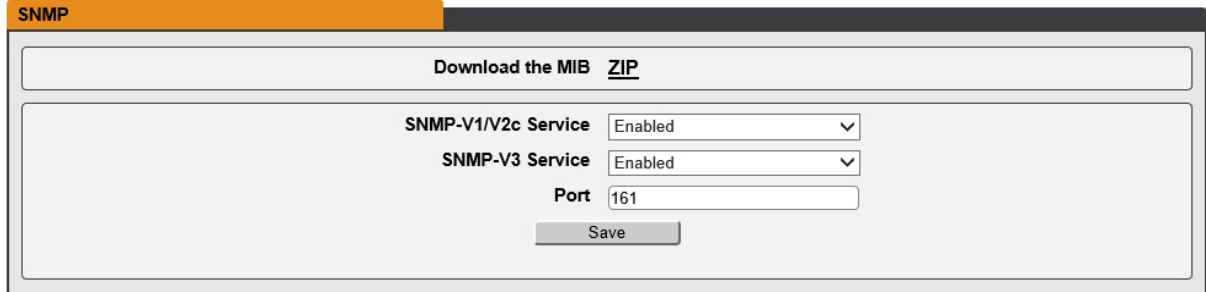

The screenshot shows the SNMP configuration page. At the top, there is a link to "Download the MIB ZIP". Below this, there are two dropdown menus for "SNMP-V1/V2c Service" and "SNMP-V3 Service", both set to "Enabled". A text input field for "Port" is set to "161". A "Save" button is located at the bottom of the configuration area.





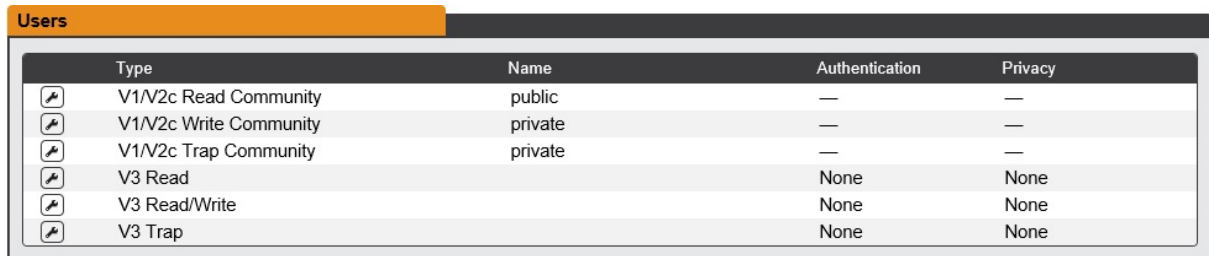

The **SNMP-V1/V2c** and **SNMP-V3 Service** can be enabled or disabled independently as desired. The service will normally listen for data-read requests (a.k.a. "GET requests") on **Port 161**, which is the usual default for SNMP services; this can also be changed if desired.

The Management Information Base (MIB) can be downloaded from the unit, if needed, via the MIB link at the top of the web page. Clicking this link will download a .ZIP archive containing both the MIB file itself, and a CSV-formatted spreadsheet describing the available OIDs in a human-readable form to assist you in setting up your SNMP manager to read data from the unit.

Figure 3-41 SNMP Users Configuration Page



The screenshot shows the SNMP Users configuration page. It features a table with columns for Type, Name, Authentication, and Privacy. Each row includes a Modify icon (a pencil) to the left of the Type column.

Type	Name	Authentication	Privacy
 V1/V2c Read Community	public	—	—
 V1/V2c Write Community	private	—	—
 V1/V2c Trap Community	private	—	—
 V3 Read		None	None
 V3 Read/Write		None	None
 V3 Trap		None	None

The **Users** section allows you to configure the various Read, Write, and Trap communities for SNMP services. You can also configure the authentication types and encryption methods used for the SNMP v3 if desired. Click the Modify icon to change settings.

Figure 3-42 SNMP Traps Configuration Page



The screenshot shows the top portion of the SNMP Traps configuration page. It includes a "Traps" header and a table with columns for Host, Port, and Version. A plus sign icon is visible in the first cell of the table.

Host	Port	Version
		

Traps allow you to define the trap destination IP address, the trap port number and the type of SNMP trap to be used.

Figure 3-43 SNMP Traps/Types IP Configuration Page

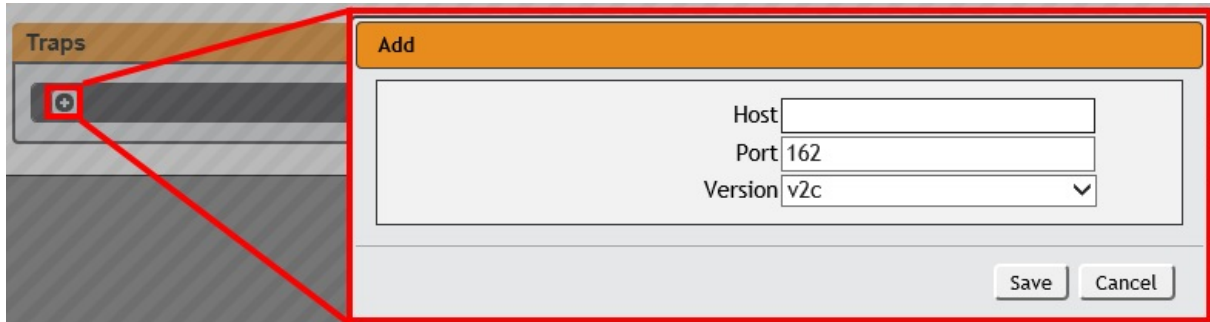
The image shows a web interface for configuring SNMP traps. On the left, there is a 'Traps' section with a table containing one entry with a '+' icon. A red box highlights this '+' icon, and a red line connects it to a larger 'Add' dialog box on the right. The 'Add' dialog box has a title bar 'Add' and three input fields: 'Host' (empty), 'Port' (162), and 'Version' (v2c with a dropdown arrow). At the bottom right of the dialog are 'Save' and 'Cancel' buttons.

To configure a trap destination:

1. Locate the **Traps** section of the SNMP page, and click on the Add icon.
2. Enter the IP Address which the trap should be sent to in the **Host** field, change the **Port** number if required, select the trap **Version** to be used (v1, v2c, or v3), and click **Save**.

A test trap may be sent by clicking on the Test icon next to the Host IP address. Trap settings can also be updated/changed by clicking the Modify icon next to the Host IP address.

## Syslog

Syslog data can be captured remotely but must first be setup and enabled via the Syslog page.



### NOTE

This function is primarily only useful for diagnostic purposes, and should normally be left Disabled unless advised to enable it by Geist technical support for troubleshooting a specific issue.

Figure 3-44 Syslog Configuration Page

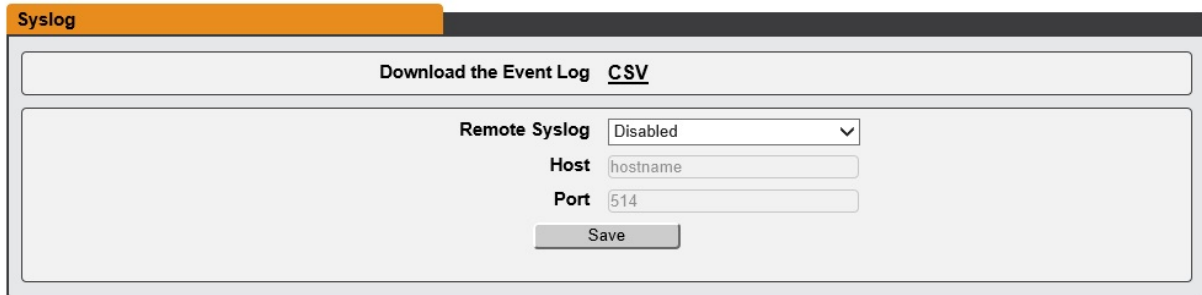

Syslog

Download the Event Log [CSV](#)

Remote Syslog

Host

Port

Save

Event log data can be downloaded by clicking on the **CSV** link at that top of the page. The event log will show system events such as user logins, configuration changes, service status, etc. The event log does not contain measurement data captured by the PDU as that data is located in the Data Log which can be found in the Sensors -> Logging page on the GUI.

## Admin

The Admin page allows the administrator of the device to save their contact information along with the device description and location. Once the info is saved by an administrator, other (non-administrator) users can view the information. Also, the System Label can be modified on this page. This label is typically shown in the title bar of the web browser's window, and/or on the browser tab(s) currently viewing the device.



### NOTE

This information is strictly for the users' and administrator's convenience. The unit will not attempt to send emails to the "Administrator Email" address and this address cannot be chosen as the Target of an Event Action when configuring an Alarm or Warning Event.

Figure 3-45 Admin Configuration Page

The screenshot shows the Admin Configuration Page. It features a header bar with the word "Admin" in white on an orange background. Below the header, there are two main sections. The first section contains five text input fields: "Description" (with "Geist R-Series PDU" entered), "Location", "Administrator Name", "Administrator Email", and "Administrator Telephone". A "Save" button is positioned below these fields. The second section contains a "System Label" text input field (with "Geist R-Series PDU" entered) and another "Save" button. Below the second "Save" button, the word "Success!" is displayed in green text.

## Locale

The Locale page sets the default Language and Temperature Units for the device. These settings will become the default viewing options for the device, although individual users can change these options for their own accounts. The Guest account will only be able to view the device with the options set here.

Figure 3-46 Locale Configuration Page

The screenshot shows the Locale Configuration Page. It features a header bar with the word "Locale" in white on an orange background. Below the header, there are two dropdown menus: "Default Language" (set to "English") and "Temperature Units" (set to "Fahrenheit"). A "Save" button is positioned below these dropdowns.

## Utilities

The Utilities page in the System menu provides the ability to backup/restore configuration, restore defaults, reboot the communication system, perform firmware updates and enable factory access.

Figure 3-47 Configuration backup and Restore Page

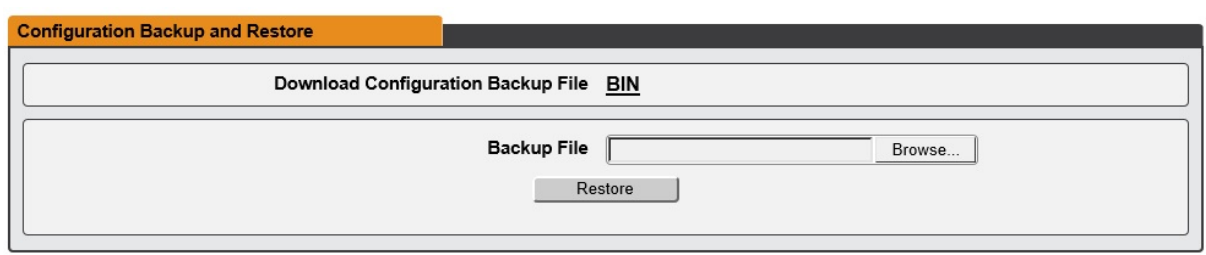

The Configuration Backup and Restore section allows the user to backup the PDU configuration file for future use in the case that the device is reset to defaults for any reason.

To download the current configuration click on the **BIN** link and save the file to an easily accessible location such as the local computer or a shared network folder.

To restore a device configuration, click the Browse button and locate the appropriate configuration file and then click the Restore button.

Figure 3-48 Restore Default Page

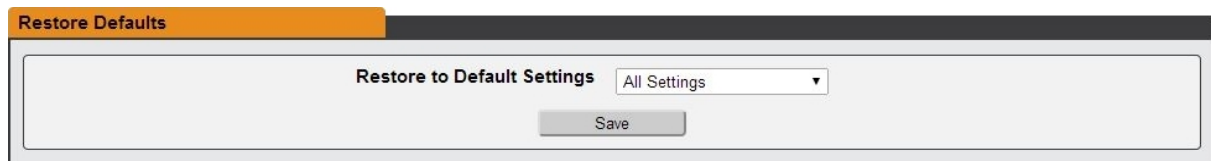

The Restore Defaults section allows the user to restore the unit's settings to the factory defaults. There are two options:

- **All Settings:** erases all of the unit's settings, including all Network and User Accounts settings, effectively reverting the entire unit back to its original out-of-the-box state.
- **All Non-Network Settings:** erases all settings except the Network and User Accounts.

Figure 3-49 Reboot Page

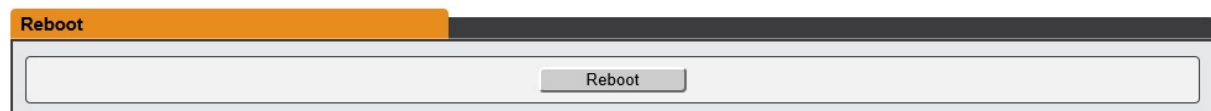

The Reboot section allows the user to perform a system reboot. This function will not affect power delivery to connected equipment.

Figure 3-50 Firmware Update Page

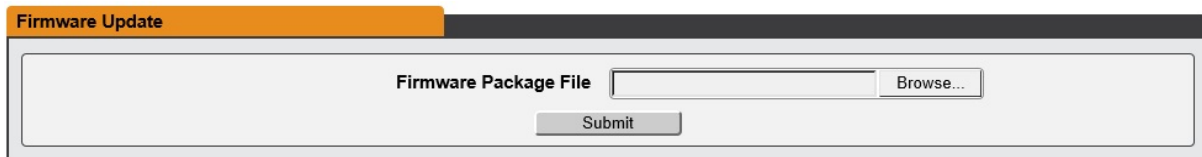

Firmware Update

Firmware Package File  Browse...

Submit

Use the Firmware Update section to load firmware updates into the unit. Firmware updates, when available, can be found on the Geist website:

<http://www.geistglobal.com/support/firmware>.

You can also subscribe to a mailing list, to be notified of when firmware updates become available.

Firmware updates will typically come in a .ZIP archive file containing several files including the firmware package itself, a copy of the SNMP MIB, a "readme" text file explaining how to install the firmware, and various other support files as needed. Be sure to un-ZIP the archive and follow the included instructions. Firmware updates will not affect power delivery to connected equipment.

Figure 3-51 Factory Access Page

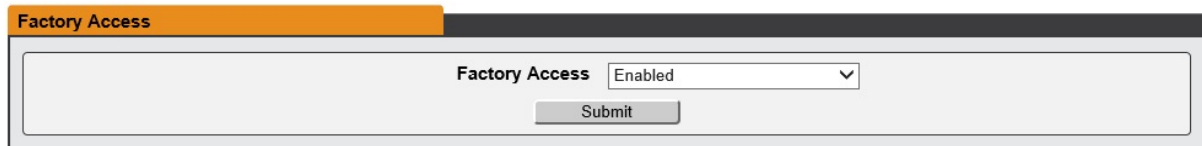

Factory Access

Factory Access Enabled

Submit

- **Factory Access:** Enabling Factory Access mode allows Geist support technicians access to more in-depth diagnostic information. It is recommended that this option be set to Disabled unless a Geist support member instructs you to enable it.



## Help

### Info

The Info Page displays the unit's current configuration information, including the device name and ID, the type of IMD installed, the unit's current firmware versions, and network information. Manufacturer support information is also here.

Figure 3-52 Info Page



<b>Info</b>	
<b>Device Name</b>	GEIST R-SERIES PDU
<b>Serial Number</b>	IS14071676
<b>Model Number</b>	RCUW248-103PK3TL15-OD
<b>Part Number</b>	15057Q
<b>Device Type</b>	Pow-Swi-250-DB
<b>Version</b>	5.2.0
<b>GUI Version</b>	1.4.0
<b>MAC Address</b>	00:19:85:e3:6b:a3
<b>Hostname</b>	quetzal
<b>Manufacturer</b>	Geist
<b>Manufacturer Site</b>	<a href="http://www.geistglobal.com">www.geistglobal.com</a>
<b>Support Site</b>	<a href="http://www.geistglobal.com/support">www.geistglobal.com/support</a>
<b>Support Email</b>	<a href="mailto:support@geistglobal.com">support@geistglobal.com</a>
<b>Support Telephone</b>	Americas <ul style="list-style-type: none"><li>• 1 888 630 4445</li></ul> Europe and Middle East <ul style="list-style-type: none"><li>• From within the UK 0845 026 3853</li><li>• From abroad +44 845 026 3853</li></ul> Asia <ul style="list-style-type: none"><li>• English +1 888 630 4445 (US Number)</li><li>• Chinese +86 755 8663 9505</li></ul>

## Support Site

Technical support can be found at <http://www.geistglobal.com/support>

### Americas

- 1 888 630 4445

### Europe and Middle East

- From within the UK 0845 026 3853
- From abroad +44 845 026 3853

### Asia

- English +1 888 630 4445 (US number)
- Chinese +86 755 8663 9505

## Communication

### Serial Interface

The R-Series PDUs provide an out-of-band, serial monitoring interface. The unit provides a RJ-45 port for RS-232 serial communication for out-of-band access to the units command line interface.

### Setup

The following describes how to wire a cable for communicating with the serial port on an R-Series PDU.

Figure 3-53 Serial Interface Wiring Info Page

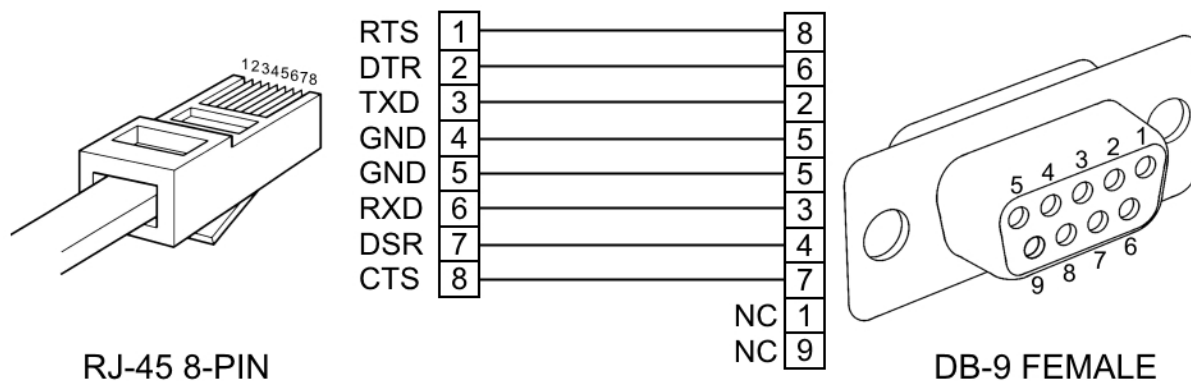

The following describes the parameters for serial communication with a R-Series PDU:

- Baud Rate: 9600
- Data Bits: 8
- Parity: N
- Stop Bits: 1
- Flow Control: None

### Communication

Serial communication is the same as the Web API commands, but using the following syntax:

```
COMMAND PATH = ARGUMENT
```

**Command** is the only required part. It is a single word from the following list: get, set, logout, add, delete, control, ack, sendTest, reset, and reboot.

**Path** is the location in the tree that you want to apply the Command. Starting at the root, each child key is separated by spaces.

**Argument** if present, is always preceded by an equal sign and is in JSON or YAML format. It is only used with the following Commands: set, add, control, and reset.

To see what the tree looks like, simply type in the following command:

```
get
```

The entire data tree is returned in YAML format. You will see some top-level keys like dev, alarm, sys, conf, etc.

To see the system configuration, you could type:

```
get conf
```

And, paying attention to the keys returned, go any number of levels deeper:

```
get conf network ethernet dhcpOn
```

To turn DHCP off you'll use an argument:

```
set conf network ethernet dhcpOn = false
```

"set" commands are special like "get" commands in that they can be applied at any level:

```
set conf network ethernet = {dhcpOn: true, ip4GW:
192.168.123.1}
```

Many commands require a device ID, a 16 character string, which can be obtained by calling:

```
get dev
```

Turn on outlet 1 with no delay (note outlets are 0-indexed)

```
control dev 0EC359E3851900C3 outlet 0 = {action: "on",
delay: "false"}
```

Turn off outlet 1 with no delay

```
control dev 0EC359E3851900C3 outlet 0 = {action: "off",
delay: "false"}
```



## NOTE

Be sure to use quotes in the parameter values.

## Technical Support

### Resetting PDU

Should the PDU lose communication, the following reset/reboot buttons are available to help with troubleshooting:

1. **Network-Reset Button** (○) : Located under the Ethernet port, users will need to use a small pin or paper clip to contact this button. Holding the Network-Reset button for 5 seconds during normal operation will restore the default IP address and reset the user accounts.

2. **Hard-Reboot Button** (↻): Pressing the Hard-Reboot button reboots the monitoring device. This acts as a power-cycle for the device, and does not change or remove any user information.



#### NOTE

This will NOT affect power to the connected devices.

### Service and Maintenance

- No service or maintenance is required.
- There are no serviceable parts inside the PDU.



#### WARNING

Do not attempt to open the PDU or the warranty will be void.

## Using Microsoft Exchange as an SMTP server

If your facility uses a Microsoft Exchange email server, it can be used by the R-Series PDU to send Alarm and Warning notification emails if desired. However, the Exchange server may need to be configured to allow SMTP connections from the unit first, as later version of Exchange often have SMTP services or basic authentication disabled by default. If you encounter difficulties in getting your IMD PDU to send emails through your Exchange server, the following notes may be helpful in resolving the problem.



### NOTE

These suggestions only apply if you are using your own, physical Exchange server! Microsoft's hosted "Office365" service utilizes a Start-TLS connection and can be setup using the standard "Office365" email server settings in the email configuration menu.

First, since the R-Series PDU cannot use IMAP or Microsoft's proprietary MAPI/RPC Exchange/Outlook protocols to send messages, you will need to enable SMTP by setting up an "SMTP Send Connector" in the Exchange server. More information on setting up an SMTP Send Connector in Exchange can be found at this Microsoft TechNet article:

<http://technet.microsoft.com/en-us/library/aa997285.aspx>

Next: Your Exchange server may also need to be configured to allow messages to be "relayed" from the monitoring unit. Typically, this will involve turning on the "**Reroute incoming SMTP mail**" option in the Exchange server's **Routing** properties, then adding the PDU's IP address as a domain which is permitted to relay mail through the Exchange server. More information about enabling and configuring SMTP relaying in Exchange can be found at this Microsoft TechNet article: <http://technet.microsoft.com/en-us/library/dd277329.aspx>

The SMTP "AUTH PLAIN" and "AUTH LOGIN" authentication methods (also known as "Basic Authentication") for logging in to the server are often no longer enabled by default in Exchange; only Microsoft's proprietary NTLM authentication method is enabled. The AUTH LOGIN method which the IMD PDU requires can be re-enabled as follows:

1. In the Exchange console under **server configuration**, select **hub transport**.
2. Right-click the client server, and select **properties**.
3. Select the **authentication** tab.
4. Check the **Basic Authentication** checkbox.
5. Uncheck the **Offer Basic only after TLS** checkbox.
6. Apply or save these changes, and exit. Note that you may need to restart the Exchange service after making these changes.

Finally, once you have enabled SMTP, relaying, and the AUTH LOGIN Basic Authentication method, you may also need to create a user account specifically for the PDU to log into. If you have already created an account prior to enabling the SMTP Send Connector, or you are trying to use an already-existing account created for another user, and the PDU still cannot seem to connect to the Exchange server, the account probably did not properly inherit the new permissions when you enabled them as above. This tends to happen more often on Exchange servers that have been upgraded since the account(s) you are trying to use were first created, but can sometimes happen with accounts when

new connectors and plug-ins are added regardless of the Exchange version. Delete the user account, then create a new one for the monitoring unit to use, and the new account should inherit the SMTP authentication and mail-relaying permissions correctly.

If none of the above suggestions succeed in allowing your Geist R-Series PDU to send mail through your Exchange server, then you may need to contact Microsoft's technical support for further assistance in configuring your Exchange server to allow SMTP emails to be sent from a 3rd-party, non-Windows device through your network.

## Chapter 4 - Final Checkout

### Product-Specific Safety Notices

The specific procedural safety precautions relating to this product are stated below.

### General Safety

Safety is a serious matter and all precautions should be taken to guarantee a safe work and operational environment. General safety precautions must be observed during all aspects of operation, service, and repair of equipment described in this document. Failure to comply with the safety warnings, procedures and guidelines as presented in this document is in violation of the safety standards of design, manufacture, and intended use of this equipment.

You are responsible for following the safety guidelines and warnings presented in this document for this equipment. Individuals using or maintaining Geist product(s) are expected to follow all the noted warnings and safety precautions necessary for safe operation of the equipment in your environment. Geist assumes no liability for failure to comply with these requirements.

### Live Circuits Safety



**DANGER**  
**HAZARDOUS VOLTAGE, CURRENT, AND ENERGY LEVELS ARE PRESENT IN THIS PRODUCT. POWER SWITCHED CIRCUITS CAN HAVE HAZARDOUS VOLTAGES PRESENT EVEN WHEN THE SWITCH IS IN THE OFF POSITION. DO NOT OPERATE THE PRODUCT WITH ANY COVER PLATE REMOVED. ALWAYS MAKE SURE THAT PRODUCT IS FULLY ENCLOSED PRIOR TO USE.**

Operating personnel must:

- Not remove equipment covers. Only Geist Authorized Service Personnel or other qualified maintenance personnel may remove equipment covers for internal sub-assembly, or component replacement, or any internal adjustment.
- Not replace any equipment component with power applied to the line cord. Under certain conditions, dangerous voltages may exist even with the input power cable disconnected. Any exceptions for 'Hot-Swap' modules will be specifically noted in this product document.

- Always disconnect input power and discharge circuits before touching any sub-assembly of circuit component.

## Equipment Grounding

To minimize shock hazard, the equipment chassis and enclosure must be connected to an electrical earth ground. The input power cable must be either plugged into an industry electrical code compatible receptacle or wired directly into an electrical code compatible interface. The equipment earth ground wire (typically green) must be firmly connected to the facility electrical safety ground. The mating electrical interface to this equipment must comply with International Electromechanical Commission (IEC) standards.

## Electrostatic Discharge

Geist strongly recommends that anti-static precautions be taken when installing, removing, or working on and around static sensitivity equipment. Industry approved anti-static devices such as wrist and heel straps, in conjunction with conductive foam pads, should be available and implemented only after verifying that they are in good working condition.

Electronic components such as memory modules, circuit boards, and LED displays, are sensitivity to Electro-Static Discharge (ESD). Handling of such components should be done only after proper anti-static workspace conditions have been established. Any static producing packing materials such as plastic, Styrofoam, and some cardboards, should be removed and discarded in a timely manner.

## Explosive Environment

Do not operate this equipment in the presence of flammable gases or fumes. Operation of any electrical equipment in such an environment constitutes a definite safety hazard.

## Servicing and Adjustments

Do not attempt to service this equipment, there are no field serviceable parts or sub-assemblies. Any adjustments should be made by authorized service personnel only.

## Repairs and Modifications

Because of the danger of electrocution and/or severe health hazard, do not install substitute parts or preform any unauthorized modifications of this equipment. It is



best to contact Geist for Warranty and Repair Service to ensure that safety features are maintained.



**Thank You For  
Purchasing Geist**

[geistglobal.com](http://geistglobal.com)

